



# ROSSOFUOCO®

*Forni a legna & Barbecues*  
*Wood burning ovens & Barbecues*



Collezione 2022 Collection



*“Le cose fatte con amore sono sempre ben fatte e hanno il dono di farsi amare.”*

*“All things done with love are always well done and have the gift of being loved.”*

*Così, con tutta la nostra passione sogniamo, pensiamo, creiamo e produciamo i nostri forni, realizzando qualcosa capace di farsi subito amare.*

*So, with all our passion we dream, think, create and produce our ovens, making something capable of being immediately loved.*



**ROSSOFUOCO®**

*Forni a Legna & Barbecues*

*Wood burning ovens & Barbecues*

## Nel cuore della Tradizione

Forse non tutti oggi hanno ricordo dell'importanza che il forno a legna ebbe nella tradizione culinaria italiana, quando le donne delle famiglie contadine vi cuocevano il pane, le carni, i dolci e tutte quelle prelibatezze genuine da cui è nata la fama della cucina italiana nel mondo. Oggi i moderni forni a legna danno a tutti la possibilità di riscoprire quegli antichi sapori in modo davvero semplice.

Perhaps few people know the importance that the wood-fired oven had in the Italian culinary tradition, when the women of peasant families cooked in the wood ovens bread, meats, desserts and many other genuine delicacies.

The fame in the world of Italian cuisine was born thanks to those women and their wood ovens. Today, modern wood-burning ovens give everyone the opportunity to rediscover those ancient flavors in a really simple way.

In the heart of  
Tradition

quality made in Italy

**100%** Made  
in Italy

Rossofuoco's products are renowned for their reliability, for great range of models that meet every need, without disappointing any expectations. The distribution network is very effective with well selected sales points, where professional retailers operate to ensure, at all times, the full satisfaction of the customer.

Many reasons that justify the full recognition of our company, in Italy and all over the world.

By choosing a Rossofuoco's oven you buy a product entirely made in Italy, with quality and reliability of all materials used, verified in every production step.

5 years warranty

**5** anni di Garanzia  
su camere di cottura e combustione  
on baking e cooking chambers  
**years warranty**

All our separated combustion ovens come with a 5 years warranty on baking and combustion chambers.

Only who is sure of his product can give so much. A certainty that comes from strict production standards.

To achieve this, Rossofuoco® uses skilled designers and expert technicians.

qualità made in Italy

I prodotti Rossofuoco® sono rinomati per la loro affidabilità e per la varietà della gamma, fatta di prodotti mirati a soddisfare molteplici esigenze senza deludere le aspettative.

La rete distributiva è quanto mai efficace con punti vendita ben selezionati dove operano rivenditori professionisti che lavorano per assicurare in ogni momento la piena soddisfazione del cliente.

Sono tante le ragioni che giustificano il pieno riconoscimento di ROSSOFUOCO®, in Italia e nel mondo.

Un'azienda che quotidianamente verifica la qualità dei processi produttivi, dei materiali, dell'affidabilità dei componenti, sempre pronta ad intervenire, anche direttamente, all'insorgere di qualsiasi problema.

garanzia di 5 anni

Cinque anni di garanzia sulle camere di cottura e di combustione di tutti i forni a combustione separata. Solo chi è sicuro del proprio prodotto può garantire tanto.

Una certezza che deriva da processi di fabbricazione secondo gli standard più rigorosi per dare sicurezza ai clienti, accompagnata dalla reperibilità per lungo tempo dei pezzi di ricambio.

Per ottenere ciò ROSSOFUOCO® si avvale di abili professionisti per la progettazione e tecnici esperti per la costruzione dei propri forni a legna.

# s i m p l i c i t y

The system of the cooking chamber separated from the combustion one, that avoids food contact with smoke **does not requires familiarity** in regulating the quantity of wood necessary to obtain the right temperature, that can be reached and mantained even by adding more of it later.

The oven can reach the right temperature in only 30/40 minutes, with just 3/4 kg of wood, keeping this temperature stable for over 2 hours after the end of combustion.



Il sistema a camera di combustione separata da quella di cottura, che evita il contatto dei cibi con i fumi, **non richiede dimestichezza** nel regolare la quantità di legna per ottenere la giusta temperatura che, si può raggiungere o mantenere anche aggiungendone successivamente dell'altra.

Ne bastano 3/4kg per arrivare alla temperatura d'impiego in soli 30/40 minuti, rimanendo pressochè costante per oltre 2 ore dopo la fine della combustione.

**The combustion intensity can be adjusted** using the smoke valve by which it may be modified the draft, or by varying the opening of the ventilation slots in the combustion chamber door.



**L'intensità della combustione è regolabile** utilizzando la valvola fumi con cui modificare il "tiraggio", o variando l'apertura delle feritoie di areazione nello sportello della camera di combustione.

**The humidity in the cooking chamber can be adjusted**, with the steam valve, while ventilation further improves the internal heat distribution for cooking.



**La valvola vapori aiuta a dosare l'umidità** nella camera di cottura, mentre la ventilazione migliora ulteriormente la distribuzione del calore per la cottura.

The electrical connection to the home network with the 12volt transformer makes it possible to use the lamp inside the oven and the ventilation, but working in complete safety.



Il collegamento elettrico alla rete domestica con il trasformatore a 12volt permette di utilizzare la lampada di illuminazione interna al forno e la ventilazione, in tutta sicurezza.

# s e m p l i c i t à

# a d d e d v a l u e

To obtain exceptional cooking qualities, the ROSSOFUOCO® separated combustion ovens are built **with an exclusive internal heat distribution system** where the flame never reaches the walls of the cooking chamber because to be heated is the dividing radiant panel placed between the combustion chamber and cooking one (1); in this cavity the heated air starts its natural circulation movement by "convection" filtering through a series of slits placed at the sides of the lower level of the cooking chamber (2) where it spreads uniformly reaching and heating each level.

This is the reason why with our ovens it is possible to cook very well even when the ventilation is off.

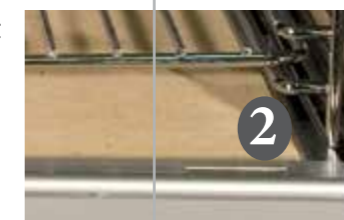
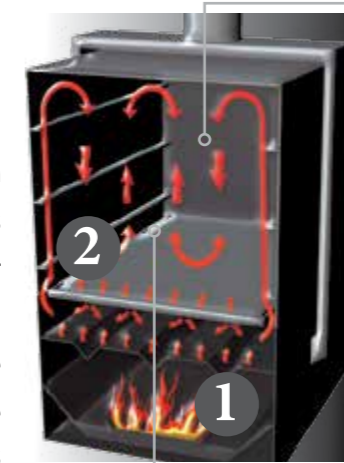

In our separate combustion ovens, the cooking chamber is squared instead of vaulted, so there is more space to place the food, even on three grills at the same time, with perfect results.

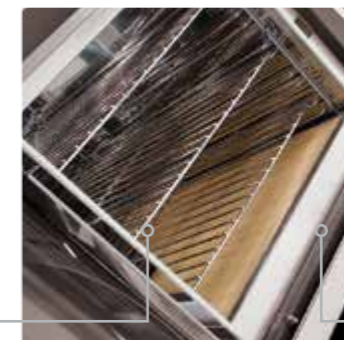

ROSSOFUOCO® ovens are available in a wide range of models entirely made in Italy with top quality materials and components along with a five-year warranty on the cooking and combustion chambers of the models with separated combustion system.



# v a l o r e a g g i u n t o

Per ottenere qualità di cottura eccezionali i forni a combustione separata ROSSOFUOCO® sono costruiti **con un sistema esclusivo di distribuzione interna del calore.**

La fiamma non entra mai a contatto diretto con la camera di cottura perché ad essere riscaldato è il pannello radiante divisorio posto tra camera di combustione e camera di cottura (1); in questa intercapedine l'aria riscaldata inizia il suo movimento di circolazione naturale per "convezione" filtrando attraverso la serie di feritoie poste ai lati del piano inferiore della camera di cottura (2) dove si diffonde uniformemente raggiungendo e riscaldando omogeneamente ogni livello; anche per questo con i nostri forni è possibile cuocere ottimamente le pietanze persino a ventilazione spenta.

La camera di cottura è quadrata anziché a volta, così lo spazio per posizionare le pietanze è più ampio e la cottura, in ogni piano, è sempre perfetta anche se li si utilizza tutti contemporaneamente.

I forni ROSSOFUOCO® sono disponibili in un'ampia gamma di modelli interamente fatti in Italia con materiali e componenti di primissima qualità insieme a ben cinque anni di garanzia su camere di cottura e combustione dei modelli a combustione separata.

## The Details

### Ergonomic "cool-grip" handles

Made to avoid risks of burns and to have an easy front clamping system.

### Anti tilting grids

All the ovens come with 2 or 3 grids that can be placed on one of the 5 level with double rack.

### Baking chamber without weldings

Made out of stainless steel it is free from unhealthy weldings; it's beautiful and really undeformable by thermal shocks.

### No weldings between baking and combustion chambers

This avoid abnormal deformations due to different dilatation of different materials caused by heat.

### Stainless steel hingers

They are fixed on the body parts and not simply on the front panel of the oven; so the lock is perfect also during high dilatation phases.

### Eco-friendly varnishes

For the best possible respect of the environment.

### Safe 12 volts electrical system

A transformer converts the standard house current to a safe 12 volts one.

### Low consumption

High performances with only 3/4 kg of wood.



## I Dettagli

### Maniglie "antiscotto"

Riducono il pericolo di scottature durante l'uso; il loro sistema a serraggio frontale garantisce una chiusura perfetta.

### Griglie antiribaltamento

1 o 2 a seconda del modello e posizionabili sui 5 livelli disponibili, possono essere fatte scorrere lungo le guide senza pericoli.

### Camera di cottura senza saldature

Realizzata in acciaio inox risulta più bella, più robusta, indeformabile agli shock termici.

### Nessuna saldatura tra camere di cottura e combustione

Evita che per il calore le dilatazioni differenti di materiali diversi alterino le camere stesse.

### Cerniere in acciaio Inox

Sono fissate al controtelaio anziché al frontale, garantendo una tenuta migliore anche in fase di forti dilatazioni.

### Vernici ecologiche

Per il massimo rispetto possibile dell'ambiente.

### Impianto elettrico più sicuro

A 12 volt, grazie al trasformatore in dotazione.

### Basso consumo

Prestazioni elevate con soli 3/4 kg di legna.

## easy maintenance

To allow a perfect and deep cleaning of the baking chamber it's possible to dismount the lateral supports of the grids by easily unlocking them from the fixing points.



The baking chamber without grids and supports.

## manutenzione facile

Per una perfetta ed accurata pulizia della camera di cottura, in acciaio inox autopulente, e raggiungerne più facilmente tutti gli angoli, è possibile smontare i supporti laterali delle griglie, sganciandoli dai loro punti di fissaggio con estrema facilità.

La camera di cottura priva di griglie e supporti



ROSSOFUOCO® ovens can be completely disassembled for total inspection and replacement of components.

The interventions can all be made from the front (fundamental detail in built-in models).

For example, to replace the fan, just open the cooking chamber, unhook the flange at the bottom, loosen the two fixing screws of the fan-motor block, unhook it, remove it and proceed with the intervention.

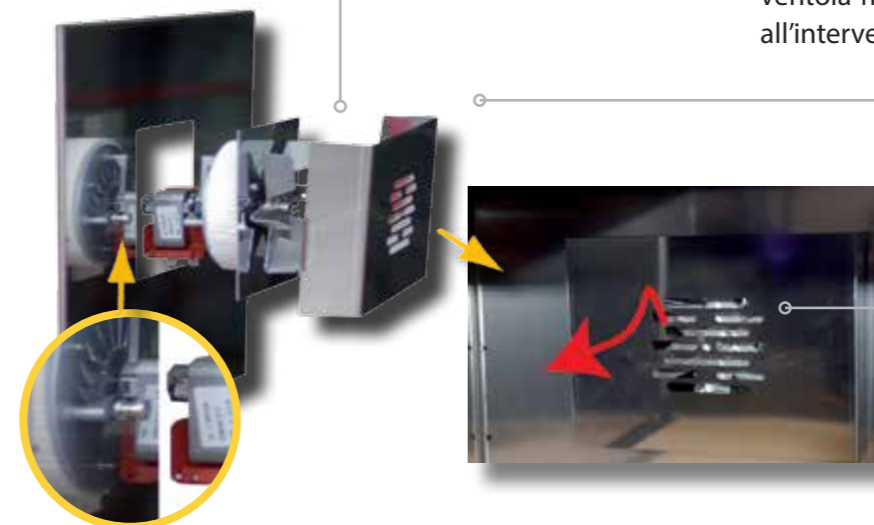

I forni ROSSOFUOCO® sono completamente smontabili per la totale ispezionabilità e per la sostituzione della componentistica.

Gli interventi avvengono tutti dal frontale (particolare fondamentale nei modelli da incasso).

Ad esempio per la sostituzione della ventola basta aprire la camera di cottura, sganciare la flangia posta in fondo, allentare le due viti di fissaggio del blocco ventola-motore, sganciarlo, sfilarlo e provvedere all'intervento.

Il fondo della camera di cottura con la flangia da sganciare.

The bottom of the cooking chamber with the flange to unhook.

# Standard and Optional Equipments

ROSSOFUOCO® ovens are rich in equipments and accessories, such as ventilation system, smoke and steam valves, timer and thermometer, internal lighting, grills, trays, refractory plate, pan holder tool, poker, shovel for bread or pizza, the glove.

Depending on the models many are standard, some others are available as an option.

Each oven is equipped with a special ash pan for easy cleaning.

They can also be equipped with cart, work tops, side or front barbecue.

# Le Dotazioni e gli Accessori

I forni a combustione separata ROSSOFUOCO® sono ricchi di dotazioni ed accessori, come la ventilazione, le valvole fumi e vapori, il timer e il termometro, l'illuminazione interna, le griglie, le teglie, l'accessorio prenditeglie, l'attizzatoio, la pala per pane o pizza, il guanto. A seconda dei modelli molti di questi sono di serie, alcuni altri sono disponibili come opzionali.

Ogni forno è dotato di un apposito cassetto raccogli cenere che ne facilita la pulizia.

Possono essere dotati anche di carrelli, di piani di lavoro, di barbecue laterale o frontale.



## FORNI A COMBUSTIONE SEPARATA PER ESTERNO OUTDOOR SEPARATED COMBUSTION OVENS

Sedicinoni, Inox - Black - Country	12-17
Steel	18-19
Fiamma	20-21
Effe	22-23
Raggio	24-25
Garden - Garden Plus	26-27
Garden Color	28-29
Eco & Eco 50	30-31



## FORNI A COMBUSTIONE SEPARATA DA INCASSO BUILT IN SEPARATED COMBUSTION OVENS

Sedicinoni, Inox - Black - Country	34-39
Steel	44-41
Fiamma	42-43
Rame	42-43
Effe	44-45
Eco	46-47
Eco 50	46-47
Garden color	48-49
Quattrostagioni	50-51



## FORNI A COTTURA DIRETTA PER ESTERNO OUTDOOR DIRECT COOKING OVENS

Più trecento	54-55
Nonna Luisa	56-57
Benni	58-59
Campagnolo	60-61
Mino	62-63



## BARBECUE BARBECUES

Easy Up (standalone)	66-67
Wood Up (standalone)	68-69
Maxi (standalone)	70-71
Falò Solo (standalone)	72-73
Falò (per forni / for ovens)	74-75
Cassetto BBQ (per forni / for ovens)	74-75



## ACCESSORI E RICAMBI EQUIPMENTS AND SPARE PARTS

Accessori / Equipment	78-75
Ricambi / Spare parts	86-90
Tabella colori / Color chart	91





 ROSSOFUOCO®

## FORNI A COMBUSTIONE SEPARATA DA ESTERNO

## OUTDOOR SEPARATED COMBUSTION OVENS

Sedicioni, Inox - Black - Country	12-17
Steel	18-19
Fiamma	20-21
Effe	22-23
Raggio	24-25
Garden - Garden Plus	26-27
Garden Color	28-29
Eco	30-31
Eco 50	30-31

# Sedicioni Inox

la praticità della camera di cottura orizzontale

great ease with the ultra-wide cooking chamber



**5** anni di Garanzia  
su camera di cottura e combustione  
on baking e cooking chambers  
years warranty

**100%** Made  
in Italy

## DOTAZIONI DI SERIE

Carrello, **doppia ventilazione**, valvole fumi e vapori, termometro, timer, illuminazione interna, 2 griglie cromate, 2 teglie rettangolari, accessorio prenditeghe, attizzatoio, comignolo antivento, guanto.

## STANDARD EQUIPMENT

Cart, **double ventilation fan**, smoke and steam valves, thermometer, timer, internal lighting, 2 chrome grilles, 2 rectangular baking pans, pan holder tool, poker, windproof chimney, oven mitt.

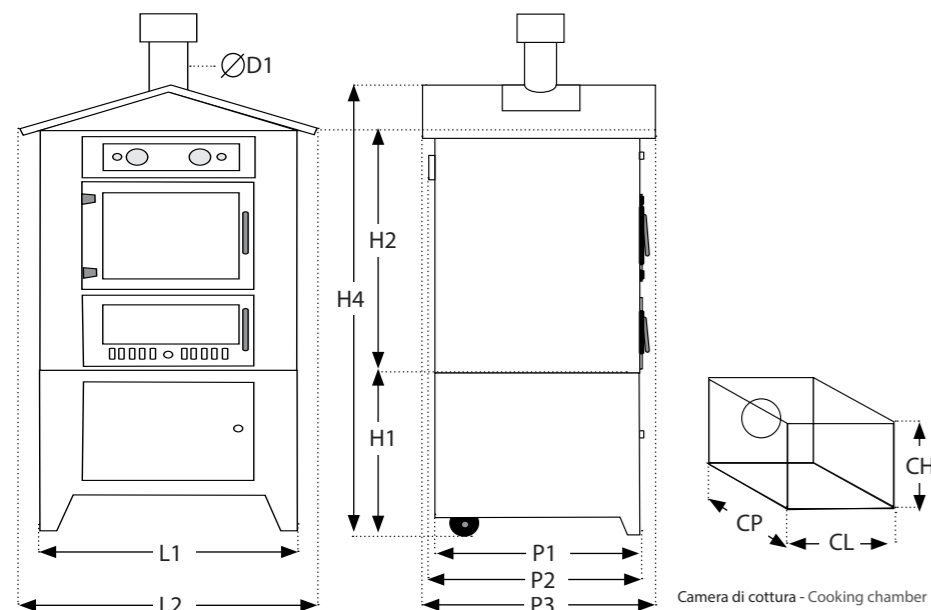

Codice modello Item code	L1	L2	P1	P2	P3	H1	H2	H4	KG	D1	CL	CP	CH	Carica legna Wood load
Sedicioni 80A-CC	1005	1250	780	820	1070	640	1000	1820	272	130	730	630	390	3/4 Kg

Dimensioni in millimetri, peso in Kg. - Dimensions in millimeters, weight in Kg.

Principali Accessori / Main accessories	
Articolo Item	Codice Code
Barbecue laterale Falò / Side barbecue "Falò"	BEF
Barbecue: Supplemento tetto inox / Surcharge for stainless steel roof	BTX
Barbecue: Opzione griglia inox / Surcharge for stainless steel grid	GBX65X
Piano di lavoro frontale / Front work top	PFW
Kit 6 pale e portapale / Kit of 6 shovels with shovel holder	

Trovi altri accessori  
da pagina 74:  
piano di lavoro laterale,  
piastra refrattaria aggiuntiva,  
pale pane pizza,  
portapale,  
griglie e teglie aggiuntive,  
cappottine....

More accessories  
starting on page 74:  
lateral work top,  
additional refractory plate,  
bread and pizza shovels,  
shovel holder,  
additional grilles and pans,  
waterproof cover....

# FORNI A COMBUSTIONE SEPARATA DA ESTERNO

OUTDOOR SEPARATED COMBUSTION OVENS

# Sedicioni Inox



Finiture in acciaio Inox - Tetto inox - Camera di cottura sviluppata orizzontalmente - Camere di cottura e combustione con vetro a specchio.  
Stainless steel front panels - Stainless steel roof - Horizontal layout of the cooking chamber - Doors with mirrored glass.

Gli accessori più richiesti

The most popular accessories



Set pale / Shovels kit



Barbecue



Piano lavoro/Work top



Kit "Porchetta"





# Sedicinoni Black

sceglilo insieme al grande barbecue a legna

choose it together with the large wood-burning barbecue



**5** anni di Garanzia  
su camere di cottura e combustione  
on baking e cooking chambers  
years warranty

**100%** Made  
in Italy

## DOTAZIONI DI SERIE

Carrello, **doppia ventilazione**, valvole fumi e vapori, termometro, timer, illuminazione interna, 2 griglie cromatiche, 2 teglie rettangolari, accessorio prenditeglie, attizzatore, comignolo antivento, guanto.

## STANDARD EQUIPMENT

Cart, **double ventilation fan**, smoke and steam valves, thermometer, timer, internal lighting, 2 chrome grilles, 2 rectangular baking pans, pan holder tool, poker, windproof chimney, oven mitt.

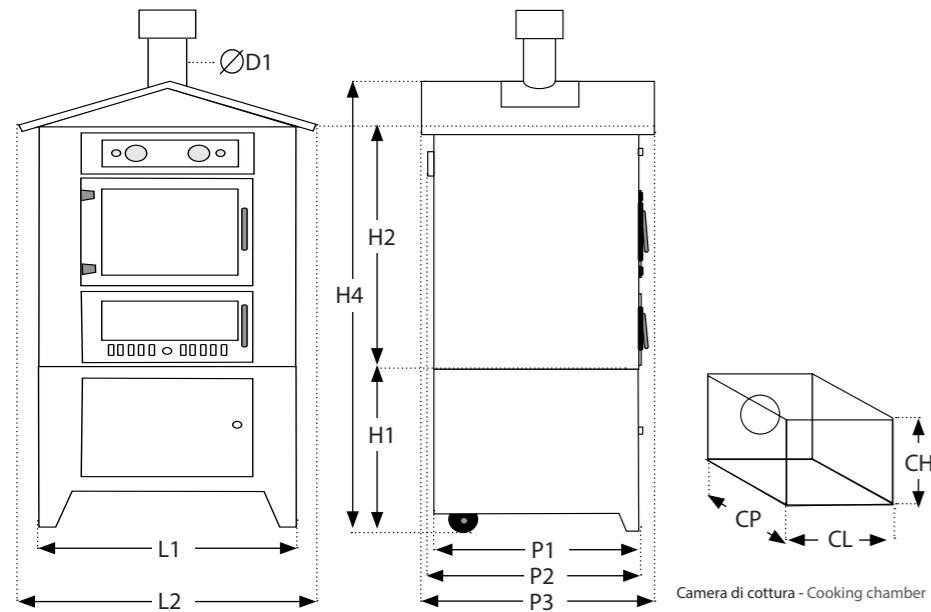

Camera di cottura - Cooking chamber

Codice modello Item code	L1	L2	P1	P2	P3	H1	H2	H4	KG	D1	CL	CP	CH	Carica legna Wood load
Sedicinoni 80B-CC	1005	1250	780	820	1070	640	1000	1820	272	130	730	630	390	3/4 Kg

Dimensioni in millimetri, peso in Kg. - Dimensions in millimeters, weight in Kg.

Principali Accessori / Main accessories	
Articolo Item	Codice Code
Barbecue laterale Falò / Side barbecue "Falò"	BEF
Barbecue: Supplemento tetto inox / Surcharge for stainless steel roof	BTX
Barbecue: Opzione griglia inox / Surcharge for stainless steel grid	GBX65X
Piano di lavoro frontale / Front work top	PFW
Kit 6 pale e portapale / Kit of 6 shovels with shovel holder	

Trovi altri accessori  
da pagina 74:  
piano di lavoro laterale,  
piastra refrattaria aggiuntiva,  
pale pane pizza,  
portapale,  
griglie e teglie aggiuntive,  
cappottine....

More accessories  
starting on page 74:  
lateral work top,  
additional refractory plate,  
bread and pizza shovels,  
shovel holder,  
additional grilles and pans,  
waterproof cover....

# FORNI A COMBUSTIONE SEPARATA DA ESTERNO

OUTDOOR SEPARATED COMBUSTION OVENS

# Sedicinoni Black



Verniciatura nera - Tetto inox - Camera di cottura sviluppata orizzontalmente - Doppia ventilazione.

Black color painted - Stainless steel roof - Horizontal layout of the cooking chamber - Double ventilation fan.



Gli accessori  
più richiesti

The most popular  
accessories



Piano lavoro/Work top



Kit "Porchetta"



Piana refrattaria aggiuntiva  
Additional refractory plate



Pala/Shovel

# Sedicinoni Country

la praticità della camera di cottura orizzontale

great ease with the ultra-wide cooking chamber



**5** anni di Garanzia  
su camera di cottura e combustione  
on baking e cooking chambers  
years warranty

**100%** Made  
in Italy

## DOTAZIONI DI SERIE

Carrello, **doppia ventilazione**, valvole fumi e vapori, termometro, timer, illuminazione interna, 2 griglie cromate, 2 teglie rettangolari, accessorio prenditeglie, attizzatoio, comignolo antivento, guanto.

## STANDARD EQUIPMENT

Cart, **double ventilation fan**, smoke and steam valves, thermometer, timer, internal lighting, 2 chrome grilles, 2 rectangular baking pans, pan holder tool, poker, windproof chimney, oven mitt.

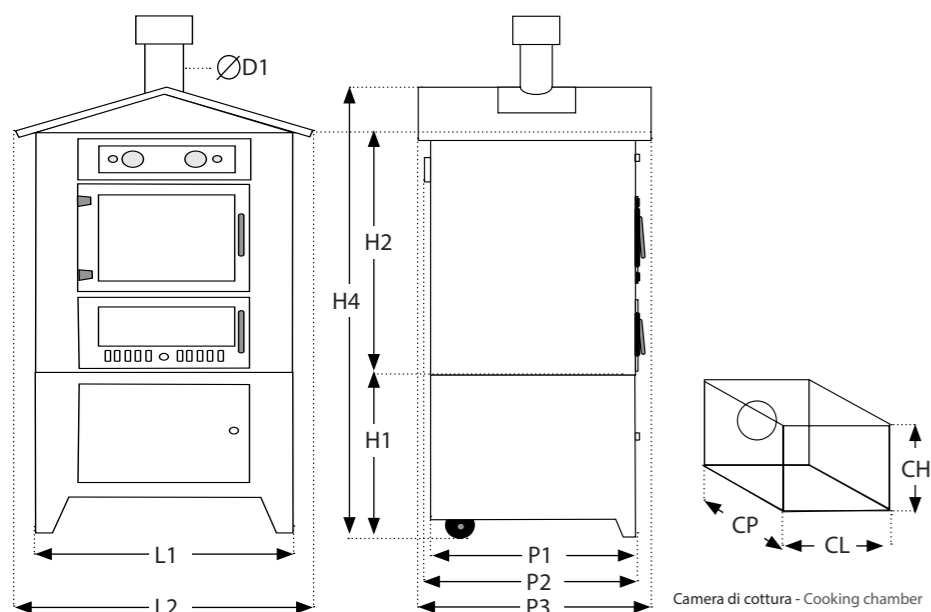

Codice modello Item code	L1	L2	P1	P2	P3	H1	H2	H4	KG	D1	CL	CP	CH	Carica legna Wood load
Sedicinoni 80C-CC	1005	1250	780	820	1070	640	1000	1820	272	130	730	630	390	3/4 Kg

Dimensioni in millimetri, peso in Kg. - Dimensions in millimeters, weight in Kg.

Principali Accessori / Main accessories	
Articolo Item	Codice Code
Barbecue laterale Falò / Side barbecue "Falò"	BEF
Barbecue: Supplemento tetto inox / Surcharge for stainless steel roof	BTX
Barbecue: Opzione griglia inox / Surcharge for stainless steel grid	GBX65X
Piano di lavoro frontale / Front work top	PFW
Kit 6 pale e portapale / Kit of 6 shovels with shovel holder	

Trovi altri accessori  
da pagina 74:

piano di lavoro laterale,  
piastra refrattaria aggiuntiva,  
pale pane pizza,  
portapale,  
griglie e teglie aggiuntive,  
cappottine....

More accessories  
starting on page 74:

lateral work top,  
additional refractory plate,  
bread and pizza shovels,  
shovel holder,  
additional grilles and pans,  
waterproof cover....

# FORNI A COMBUSTIONE SEPARATA DA ESTERNO

OUTDOOR SEPARATED COMBUSTION OVENS

# Sedicinoni Country



Verniciatura marrone - Tetto inox - Camera di cottura sviluppata orizzontalmente - Doppia ventilazione.

Brown color painted - Stainless steel roof - Horizontal layout of the cooking chamber - Double ventilation fan.

Gli accessori più richiesti

The most popular accessories



Set pale / Shovels kit



Barbecue



Piano lavoro/Work top



Kit "Porchetta"



# Steel

la forza e la bellezza dell'acciaio

the strenght and the beauty of steel

**5** anni di Garanzia  
su camere di cottura e combustione  
on baking e cooking chambers  
years warranty

**100%** Made  
in Italy



## DOTAZIONI DI SERIE

Carrello, ventilazione, valvole fumi e vapori, termometro, timer, illuminazione interna, 2 griglie cromate, 1 teglia rettangolare, accessorio prenditeglie, attizzatoio, comignolo antivento, guanto.

## STANDARD EQUIPMENT

Cart, ventilation fan, smoke and steam valves, thermometer, timer, internal lighting, 2 chrome grilles, 1 rectangular baking pan, pan holder tool, poker, windproof chimney, oven mitt.

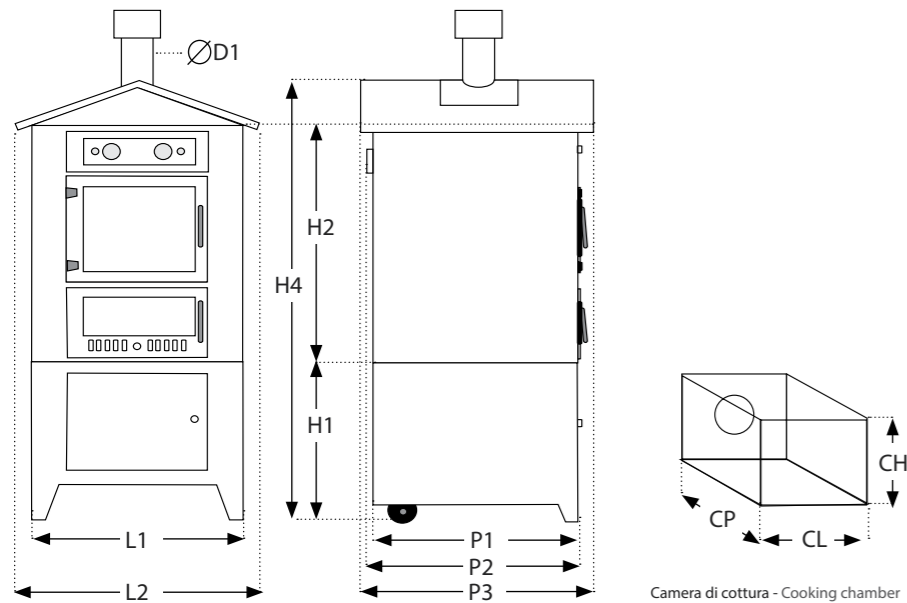

Camera di cottura - Cooking chamber

Codice modello Item code	L1	L2	P1	P2	P3	H1	H2	H4	KG*	D1	CL	CP	CH	Carica legna Wood load
Steel 65-CC	755	1000	775	815	1050	650	980	1770	229	130	480	650	420	3 kg
Steel 80-CC	805	1060	930	970	1180	650	980	1770	266	130	480	800	420	3/4 kg
Steel 100-CC	805	1060	1120	1160	1380	650	980	1770	320	130	480	1000	420	4 kg

Dimensioni in millimetri, peso in Kg. - Dimensions in millimeters, weight in Kg.

Accessori / Accessories				
Per For	Barbecue laterale "Falò" Side barbecue "Falò"	Piano laterale Side work top	Kit Porchetta Kit for big roasts	
Steel 65-CC	BEF	PA 65	GP65KIT	
Steel 80-CC	BEF	PA 80/100	GP80KIT	
Steel 100-CC	BEF	PA 80/100	GP100KIT	
Barbecue: Opzione tetto inox / Surcharge for stainless steel roof			BTX	
Barbecue: Opzione griglia inox / Surcharge for stainless steel grid			GBX65X	

Trovi altri accessori  
da pagina 74:  
mensola frontale,  
piastra refrattaria aggiuntiva,  
pale pane pizza,  
portapale,  
griglie e teglie aggiuntive,  
cappottine....

More accessories  
starting on page 74:  
front shelf,  
additional refractory plate,  
bread and pizza shovels,  
shovel holder,  
additional grilles and pans,  
waterproof cover....

# FORNI A COMBUSTIONE SEPARATA DA ESTERNO

OUTDOOR SEPARATED COMBUSTION OVENS



Struttura frontale acciaio inox - Tetto Inox - Vetri a specchio nelle camere di cottura e combustione.  
Stainless steel front panels - Stainless steel roof - Doors with mirrored glass.

Gli accessori più richiesti

The most popular accessories



Set pale / Shovels kit



Barbecue



Piano lavoro/Work top



Kit "Porchetta"





**5** anni di Garanzia  
su camere di cottura e combustione  
on baking e cooking chambers  
years warranty

**100%** Made  
in Italy

**DOTAZIONI DI SERIE**

Carrello, ventilazione, valvole fumi e vapori, termometro, timer, illuminazione interna, 2 griglie cromate, 1 teglia rettangolare, accessorio prenditeglie, attizzatoio, comignolo antivento, guanto.

**STANDARD EQUIPMENT**

Cart, ventilation fan, smoke and steam valves, thermometer, timer, internal lighting, 2 chrome grilles, 1 rectangular baking pan, pan holder tool, poker, windproof chimney, oven mitt.

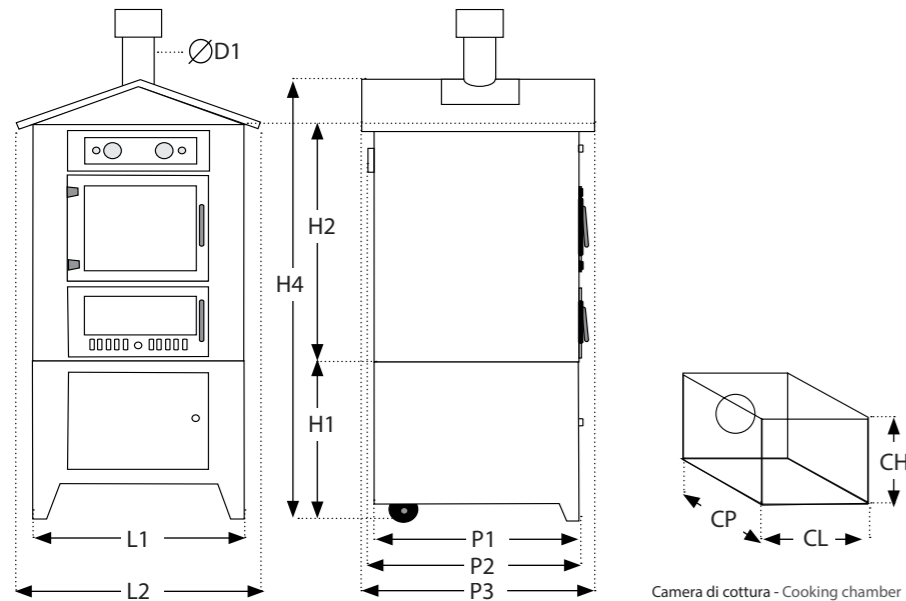

Codice modello Item code	L1	L2	P1	P2	P3	H1	H2	H4	KG*	D1	CL	CP	CH	Carica legna Wood load
Fiamma 65-CC	755	1000	775	815	1050	650	980	1770	229	130	480	650	420	3 kg
Fiamma 80-CC	805	1060	930	970	1180	650	980	1770	266	130	480	800	420	3/4 kg
Fiamma 100-CC	805	1060	1120	1160	1380	650	980	1770	320	130	480	1000	420	4 kg

Dimensioni in millimetri, peso in Kg. - Dimensions in millimeters, weight in Kg.

Principali Accessori / Main accessories				
Per For	Barbecue laterale "Falò" Side barbecue "Falò"	Piano laterale Side work top	Kit Porchetta Kit for big roasts	
Fiamma 65-CC	BEF	PA 65	GP65KIT	
Fiamma 80-CC	BEF	PA 80/100	GP80KIT	
Fiamma 100-CC	BEF	PA 80/100	GP100KIT	
Barbecue: Opzione tetto inox / Surcharge for stainless steel roof			BTX	
Barbecue: Opzione griglia inox / Surcharge for stainless steel grid			GBX65X	

Trovi altri accessori da pagina 74:  
mensola frontale, piastra refrattaria aggiuntiva, pale pane pizza, portapale, griglie e teglie aggiuntive, cappottine....

More accessories starting on page 74:  
front shelf, additional refractory plate, bread and pizza shovels, shovel holder, additional grilles and pans, waterproof cover....

**FORNI A COMBUSTIONE SEPARATA DA ESTERNO**  
OUTDOOR SEPARATED COMBUSTION OVENS

Struttura verniciata - Tetto Inox - Inserti in acciaio inox - Vetri stondati.  
Body painted - Stainless steel roof - Stainless steel finishes - Rounded glasses.

Gli accessori più richiesti

The most popular accessories



Set pale / Shovels kit



Barbecue



Piano lavoro / Work top



Kit "Porchetta"



Effe

solida bellezza e massima efficienza

solid beauty and maximum efficiency



**5** anni di Garanzia  
su camere di cottura e combustione  
on baking e cooking chambers  
years warranty

**100%** Made  
in Italy

**DOTAZIONI DI SERIE**

Carrello, ventilazione, valvole fumi e vapori, termometro, timer, illuminazione interna, 2 griglie cromate, 1 teglia rettangolare, accessorio prenditeglie, attizzatoio, comignolo antivento, guanto.

**STANDARD EQUIPMENT**

Cart, ventilation fan, smoke and steam valves, thermometer, timer, internal lighting, 2 chrome grilles, 1 rectangular baking pan, pan holder tool, poker, windproof chimney, oven mitt.

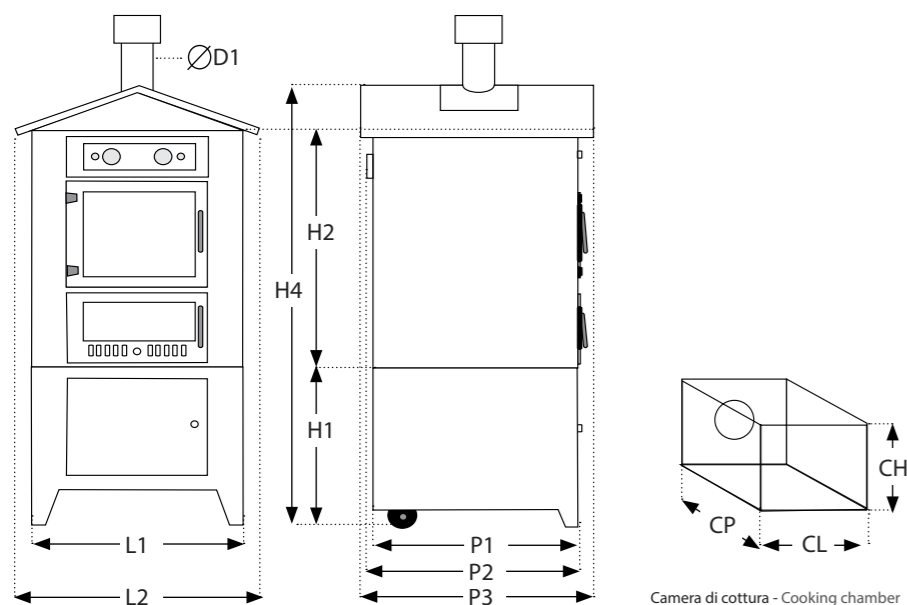

Camera di cottura - Cooking chamber

Codice modello Item code	L1	L2	P1	P2	P3	H1	H2	H4	KG*	D1	CL	CP	CH	Carica legna Wood load
Effe 65-CC	755	1000	775	815	1050	650	980	1770	229	130	480	650	420	3 kg
Effe 80-CC	805	1060	930	970	1180	650	980	1770	266	130	480	800	420	3/4 kg
Effe 100-CC	805	1060	1120	1160	1380	650	980	1770	320	130	480	1000	420	4 kg

Dimensioni in millimetri, peso in Kg. - Dimensions in millimeters, weight in Kg.

**Principali Accessori / Main accessories**

Per For	Barbecue laterale "Falò" Side barbecue "Falò"	Piano laterale Side work top	Kit Porchetta Kit for big roasts	
Effe 65-CC	BEF	PA 65	€ 94,00	GP65KIT
Effe 80-CC	BEF	PA 80/100	€ 100,00	GP80KIT
Effe 100-CC	BEF	PA 80/100	€ 100,00	GP100KIT
Barbecue: Opzione tetto inox / Surcharge for stainless steel roof			BTX	
Barbecue: Opzione griglia inox / Surcharge for stainless steel grid			GBX65X	

Trovi altri accessori da pagina 74:  
mensola frontale, piastra refrattaria aggiuntiva, pale pane pizza, portapale, griglie e teglie aggiuntive, cappottine....

More accessories starting on page 74:  
front shelf, additional refractory plate, bread and pizza shovels, shovel holder, additional grilles and pans, waterproof cover....

**FORNI A COMBUSTIONE SEPARATA DA ESTERNO**  
OUTDOOR SEPARATED COMBUSTION OVENS



Struttura verniciata - Tetto Inox - Bordatura vetri in acciaio inox - Consolle strumenti con ribaltina di protezione.  
Body painted - stainless steel roof - Glasses with steel frame - Control panel protected by tilting lid.

Gli accessori più richiesti

The most popular accessories



Set pale / Shovels kit



Barbecue



Piano lavoro/Work top



Kit "Porchetta"



# Raggio

bello con le sue linee stondate

beautiful with its rounded profiles

**5** anni di Garanzia  
su camere di cottura e combustione  
on baking e cooking chambers  
years warranty

**100%** Made  
in Italy

La mensolina  
frontale  
integrata  
The small  
front  
shovel



## DOTAZIONI DI SERIE

Carrello, ventilazione, valvole fumi e vapori, termometro, timer, illuminazione interna, mensolina frontale, 2 griglie cromate, 1 teglia rettangolare, accessorio prenditeglie, attizzatoio, comignolo antivento, guanto.

## STANDARD EQUIPMENT

Cart, ventilation fan, smoke and steam valves, thermometer, timer, internal lighting, small front shelf, 2 chrome grilles, 1 rectangular baking pan, pan holder tool, poker, windproof chimney, oven mitt.

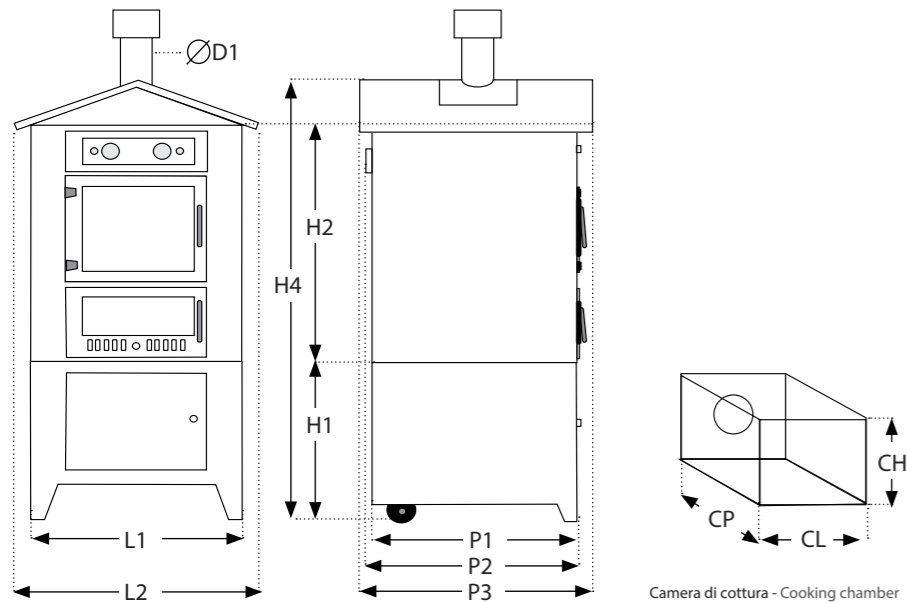

Camera di cottura - Cooking chamber

Codice modello Item code	L1	L2	P1	P2	P3	H1	H2	H4	KG	D1	CL	CP	CH	Carica legna Wood load
Raggio 80-CC	750	850	913	953	1080	641	975	1765	266	130	480	800	420	3/4 kg

Dimensioni in millimetri, peso in Kg. - Dimensions in millimeters, weight in Kg.

Principali Accessori / Main accessories			
Per For	Barbecue estraibile Pull-out Barbecue	Piano laterale Side work top	Kit Porchetta Kit for big roasts
Raggio 80-CC	BCF	PA 80/100	GP80KIT

Trovi altri accessori  
da pagina 74:  
barbecue laterale Falò  
mensola frontale,  
piastra refrattaria aggiuntiva,  
pale pane pizza,  
portapale,  
griglie e teglie aggiuntive,  
cappottine....

More accessories  
starting on page 74:  
side barbecue Falò  
front shelf,  
additional refractory plate,  
bread and pizza shovels,  
shovel holder,  
additional grilles and pans,  
waterproof cover....

# FORNI A COMBUSTIONE SEPARATA DA ESTERNO

OUTDOOR SEPARATED COMBUSTION OVENS

**Raggio**

Struttura verniciata Marrone ossido - Tetto nero - Bordatura stondate - Mensolina frontale  
Body Brown Oxide painted - Black painted roof - Rounded edging - Small front shelf



Gli accessori più richiesti

The most popular accessories



Set pale / Shovels kit



Barbecue



Piano lavoro/Work top



Kit "Porchetta"



# Garden & Garden Plus

semplici essenziali funzionali

simply a smart choice

**5** anni di Garanzia  
su camere di cottura e combustione  
on baking and cooking chambers  
years warranty

**100%** Made  
in Italy

Barbecue estraibile opzionale  
Optional pull-out BBQ

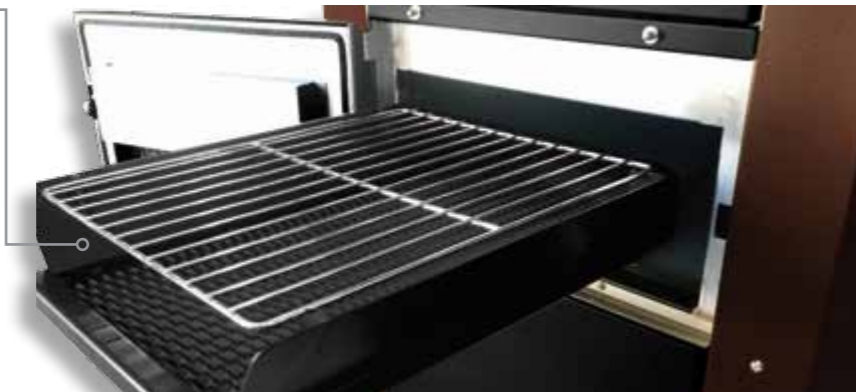

## DOTAZIONI DI SERIE

Carrello integrato nella struttura, ventilazione, valvole fumi e vapori, termometro, illuminazione interna, 2 griglie cromatiche, 1 teglia, accessorio prenditeglie, attizzatoio, comignolo antivento, guanto.

## STANDARD EQUIPMENT

Cart integrated in the structure, ventilation fan, smoke and steam valves, thermometer, internal lighting, 2 chrome grilles, 1 baking pan, pan holder tool, poker, windproof chimney, oven mitt.

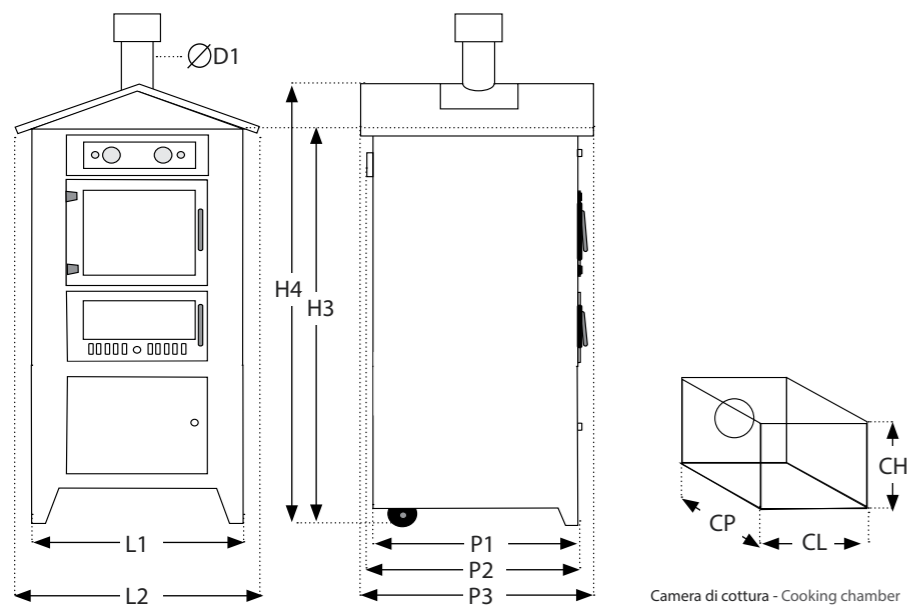

Camera di cottura - Cooking chamber

Modello Item	Codice Code	L1	L2	P1	P2	P3	H3	H4	KG	D1	CL	CP	CH	Carica legna Wood load
Garden	GAR 80	755	925	925	965	1080	1615	1755	266	130	480	800	420	3/4 kg
	GAR 100	755	1055	1120	1160	1380	1615	1755	320	130	480	1000	420	4 kg
Garden Plus	GAR 80P	755	1055	925	965	1160	1615	1755	266	130	480	800	420	3/4 kg
	GAR 100P	755	1055	1120	1160	1380	1615	1755	320	130	480	1000	420	4 kg

Dimensioni in millimetri, peso in Kg. - Dimensions in millimeters, weight in Kg.

### Principali Accessori / Main accessories

Per For	Barbecue estraibile Pull-out Barbecue	Piana refrattaria aggiuntiva Additional refractory plate	Kit Porchetta Kit for big roasts
Garden 80/80Plus	BCF	PB80	GP80KIT
Garden 100/100Plus	non disp / not available	PB100	GP100KIT
Vetro su camera di combustione / Glass on combustion chamber			GAVTCC
Plano di lavoro laterale / Side work top			PA80/100

Trovi altri accessori da pagina 74:

barbecue laterale Falò mensola frontale, pale pane pizza, portapale, griglie e teglie aggiuntive, cappottine....

More accessories starting on page 74:

side barbecue Falò front shelf, bread and pizza shovels, shovel holder, additional grilles and pans, waterproof cover....

# FORNI A COMBUSTIONE SEPARATA DA ESTERNO

OUTDOOR SEPARATED COMBUSTION OVENS

# Garden & Garden Plus



Struttura monoblocco (carrello/forno) verniciata marrone - Garden: tetto verniciato nero - Garden Plus: tetto Inox.  
Brown painted monoblock structure (oven/cart) - Garden: black painted roof - Garden Plus: stainless steel roof.



Porta camera di combustione con vetro opzionale, per entrambi i modelli  
Door of combustion chamber with glass on demand for both models

# Garden Color

pensa a colori

think colored

**5** anni di Garanzia  
su camera di cottura e combustione  
on baking e cooking chambers  
years warranty

**100%** Made  
in Italy

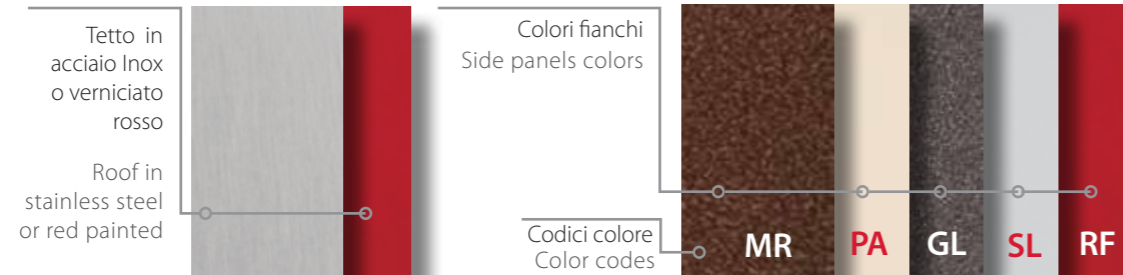

## DOTAZIONI DI SERIE

Carrello, ventilazione, valvole fumi e vapori, termometro, timer, illuminazione interna, 2 griglie cromate, 1 teglia, accessorio prenditeglie, attizzatoio, comignolo antivento, guanto.

## STANDARD EQUIPMENT

Cart, ventilation fan, smoke and steam valves, thermometer, timer, internal lighting, 2 chrome grilles, 1 baking pan, pan holder tool, poker, windproof chimney, oven mitt.

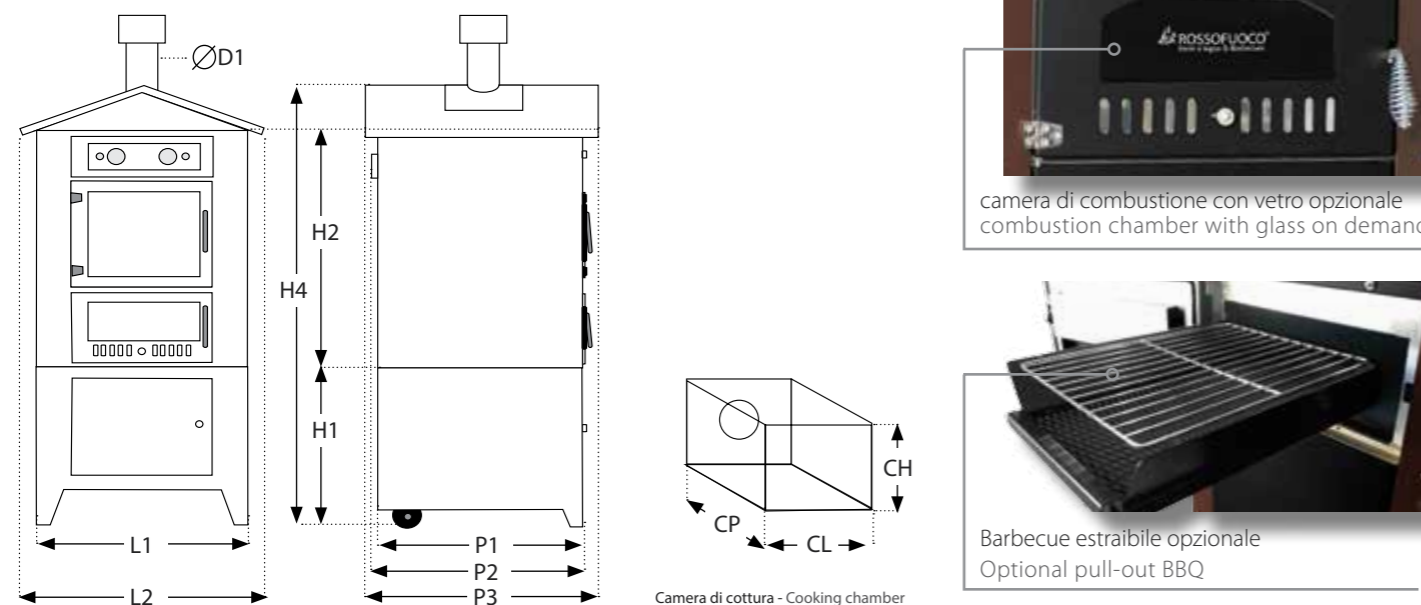

Codice modello Item code	L1	L2	P1	P2	P3	H1	H2	H4	KG	D1	CL	CP	CH	Carica legna Wood load
GAC80CM- ** Struttura Marrone+tetto Rosso Body Brown+Red roof	805	1060	930	970	1180	650	980	1770	266	130	480	800	420	3/4 kg
GAC80CG- ** Struttura Grigio L. +tetto Rosso Body Brown+Red roof														

Dimensioni in millimetri, peso in Kg. - Dimensions in millimeters, weight in Kg.

(**): Codice aggiuntivo per colore dei fianchi (*): Additional code for color of sides	GL	MR	SL	RF	PA
	Grigio Lava Lava Grey	Marrone Brown	Grigio Silver Silver Grey	Rosso Red	Panna cream

Principali Accessori / Main accessories					
Per For	Barbecue estraibile Pull-out Barbecue	Piana refrattaria aggiuntiva Additional refractory plate	Kit Porchetta Kit for big roasts		
Garden Color 80	BCF	PB80	GP80KIT		
Supplemento per tetto inox / Surcharge for stainless steel roof			TX80		
Vetro su camera di combustione / Glass on combustion chamber			GAVTCC		
Piano di lavoro laterale / Side work top			PA80/100		

Trovi altri accessori da pagina 74:  
barbecue laterale Falò  
mensola frontale,  
pale pane pizza,  
portapale,  
griglie e teglie aggiuntive,  
cappottine....

More accessories starting on page 74:  
side barbecue Falò  
front shelf,  
bread and pizza shovels,  
shovel holder,  
additional grilles and pans,  
waterproof cover....

# FORNI A COMBUSTIONE SEPARATA DA ESTERNO

OUTDOOR SEPARATED COMBUSTION OVENS

# Garden Color

Combinazione colori personalizzabile tra frontale, fianchi, tetto - Carrello separato dal corpo del forno.  
Customizable colors combination of front, sides, roof - Cart separated from the body of the oven.





# Eco & Eco 50

la semplicità che dona grandi soddisfazioni

the simplicity that gives great satisfaction

**5** anni di Garanzia  
su camere di cottura e combustione  
on baking and cooking chambers  
years warranty

**100%** Made  
in Italy



## DOTAZIONI DI SERIE

**Eco:** Carrello, ventilazione, valvole fumi e vapori, termometro, timer, illuminazione interna, 2 griglie cromate, 1 teglia rettangolare, accessorio prenditeglie, attizzatoio, comignolo antivento, guanto.

**Eco 50:** Carrello, ventilazione, termometro, timer, illuminazione interna, 2 griglie cromate, 1 teglia, accessorio prenditeglie, attizzatoio, comignolo antivento, guanto.

## STANDARD EQUIPMENT

**Eco:** Cart, ventilation fan, smoke and steam valves, thermometer, timer, internal lighting, 2 chrome grilles, 1 rectangular baking pan, pan holder tool, poker, windproof chimney, oven mitt.

**Eco 50:** Cart, ventilation fan, thermometer, timer, internal lighting, 2 chrome grilles, 1 baking pan, pan holder tool, poker, windproof chimney, oven mitt.

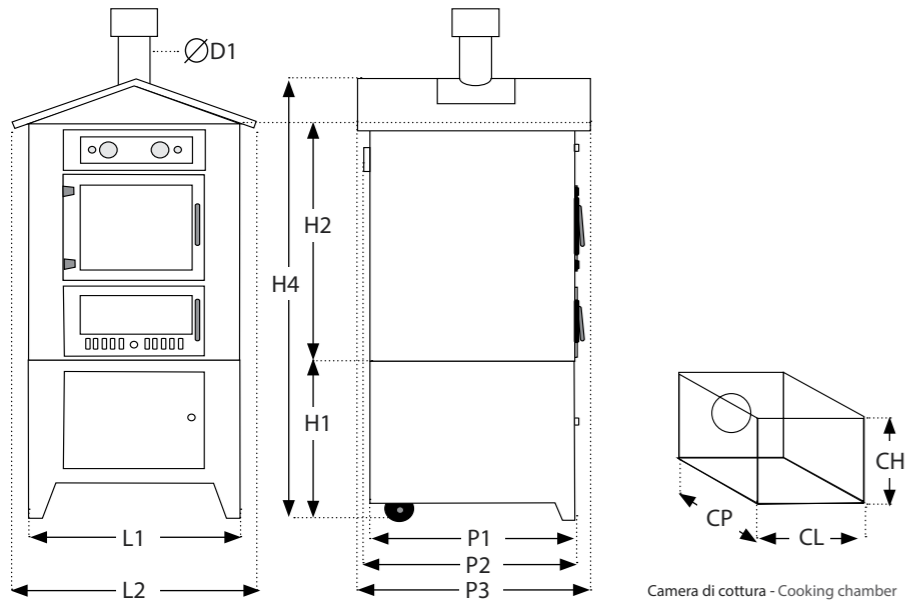

Camera di cottura - Cooking chamber

Codice modello Item code	L1	L2	P1	P2	P3	H1	H2	H4	KG	D1	CL	CP	CH	Carica legna Wood load
Eco 65-CC	755	1000	775	815	1050	650	980	1770	229	130	480	650	420	3 kg
Eco 80-CC	805	1060	930	970	1180	650	980	1770	266	130	480	800	420	3/4 kg
Eco 100-CC	805	1060	1120	1160	1380	650	980	1770	320	130	480	1000	420	4 kg
Eco 50-CC	615	840	650	690	890	715	850	1745	150	130	400	500	400	3 kg

Dimensioni in millimetri, peso in Kg. - Dimensions in millimeters, weight in Kg.

## Principali Accessori / Main accessories

Per For	Barbecue laterale "Falò" Side barbecue "Falò"	Piano laterale Side work top	Kit Porchetta Kit for big roasts
Eco 65-CC	BEF	PA 65	GP65KIT
Eco 80-CC	BEF	PA 80/100	GP80KIT
Eco 100-CC	BEF	PA 80/100	GP100KIT
Eco 50-CC	Non disp./Not available	PA 50	Non disp./Not available
Supplemento per tetto Inox forni da 65/80/100 Surcharge for roof in stainless steel ovens 65/80/100			TX **

Trovi altri accessori  
da pagina 74:  
mensola frontale,  
piastra refrattaria aggiuntiva,  
pale pane pizza,  
portapale,  
griglie e teglie aggiuntive,  
cappottine....

More accessories  
starting on page 74:  
front shelf,  
additional refractory plate,  
bread and pizza shovels,  
shovel holder,  
additional grilles and pans,  
waterproof cover....

# FORNI A COMBUSTIONE SEPARATA DA ESTERNO

OUTDOOR SEPARATED COMBUSTION OVENS

# Eco & Eco 50



Struttura verniciata - Tetto verniciato rosso - Eco 50 ha dimensioni piu compatte.  
Body painted - Red painted roof - Eco 50 has a smaller size.



Eco  
65/80/100



Eco 50



ROSSOFUOCO®

**FORNI A COMBUSTIONE SEPARATA  
DA INCASSO**

**BUILT IN  
SEPARATED COMBUSTION OVENS**

Sedicinoni, Inox - Black - Country	34-39
Steel	44-41
Fiamma	42-43
Rame	42-43
Effe	44-45
Eco	46-47
Eco 50	46-47
Garden color	48-49
Quattrostagioni	50-51

# Sedicinoni Inox

la praticità della camera di cottura orizzontale

great ease with the ultra-wide cooking chamber



**5** anni di Garanzia  
su camera di cottura e combustione  
on baking and cooking chambers  
years warranty

**100%** Made  
in Italy

## DOTAZIONI DI SERIE

**Doppia ventilazione**, valvole fumi e vapori, termometro, timer, illuminazione interna, 2 griglie cromate, 2 teglie rettangolari, accessorio prenditeglie, attizzatoio, guanto.

## STANDARD EQUIPMENT

**Double ventilation fan**, smoke and steam valves, thermometer, timer, internal lighting, 2 chrome grilles, 2 rectangular baking pans, pan holder tool, poker, oven mitt.

Vista frontale - View from the front

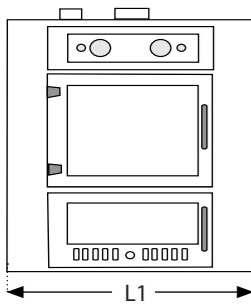

Vista laterale - View from the side

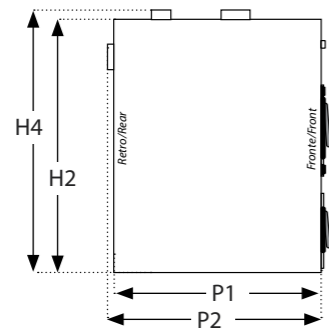

Vista dall'alto - View from the top

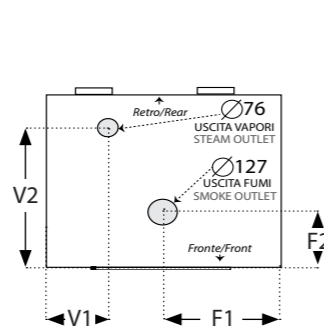

Camera di cottura - Cooking chamber

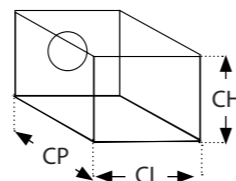

Codice modello Item code	L1	P1	P2	H2	H4	F1	F2	V1	V2	KG	CL	CP	CH	Carica legna Wood load
Sedicinoni 80iA	1005	780	820	1000	1040	502	270	335	640	200	730	630	390	3/4 Kg

Dimensioni in millimetri, peso in Kg. - Dimensions in millimeters, weight in Kg.

### Principali Accessori / Main accessories

Articolo / Item	Codice Code
Supporto fisso per forno / Special stand for oven	SW
Kit Porchetta / Kit for big roasts	GPWKIT
Piana refrattaria aggiuntiva / Additional refractory plate	PBWSC

Trovi altri accessori da pagina 74: teglie speciali, pale pane pizza, portapale, griglie e teglie aggiuntive...

More accessories starting on page 74: special pans, bread and pizza shovels, shovel holder additional grilles and pans...

# FORNI A COMBUSTIONE SEPARATA DA INCASSO

BUILT IN SEPARATED COMBUSTION OVENS

# Sedicinoni Inox



Finiture in acciaio Inox - Camera di cottura sviluppata orizzontalmente - Camere di cottura e combustione con vetri a specchio.  
Stainless steel front panels - Stainless steel roof - Horizontal layout of the cooking chamber - Doors with mirrored glass.



Gli accessori più richiesti

The most popular accessories



Piana refrattaria aggiuntiva  
Additional refractory plate



Kit "Porchetta"



Pala/Shovel



Portapale / Shovels kit

# Sedicinoni Black

tutto in vista con la camera di cottura orizzontale

great ease with the ultra-wide cooking chamber



**5** anni di Garanzia  
su camera di cottura e combustione  
on baking and cooking chambers  
years warranty

**100%** Made  
in Italy

## DOTAZIONI DI SERIE

**Doppia ventilazione**, valvole fumi e vapori, termometro, timer, illuminazione interna, 2 griglie cromate, 2 teglie rettangolari, accessorio prenditeglie, attizzatoio, guanto.

## STANDARD EQUIPMENT

**Double ventilation fan**, smoke and steam valves, thermometer, timer, internal lighting, 2 chrome grilles, 2 rectangular baking pans, pan holder tool, poker, oven mitt.

Vista frontale - View from the front

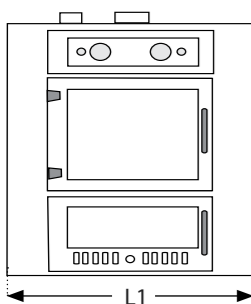

Vista laterale - View from the side

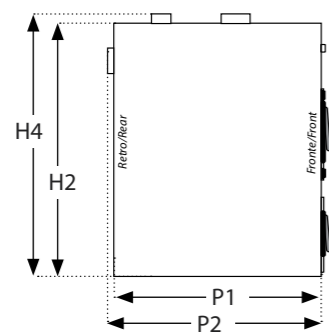

Vista dall'alto - View from the top

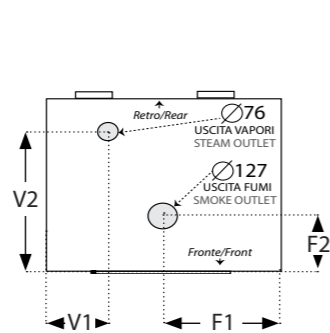

Camera di cottura - Cooking chamber

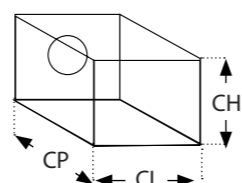

Codice modello Item code	L1	P1	P2	H2	H4	F1	F2	V1	V2	KG	CL	CP	CH	Carica legna Wood load
Sedicinoni 80iB	1005	780	820	1000	1040	502	270	335	640	200	730	630	390	3/4 Kg

Dimensioni in millimetri, peso in Kg. - Dimensions in millimeters, weight in Kg.

Principali Accessori / Main accessories	
Articolo / Item	Codice Code
Supporto fisso per forno / Special stand for oven	SW
Kit Porchetta / Kit for big roasts	GPWKIT
Piana refrattaria aggiuntiva / Additional refractory plate	PBWSC

Trovi altri accessori da pagina 74: teglie speciali, pale pane pizza, portapale, griglie e teglie aggiuntive...

More accessories starting on page 74: special pans, bread and pizza shovels, shovel holder, additional grilles and pans...

# FORNI A COMBUSTIONE SEPARATA DA INCASSO

BUILT IN SEPARATED COMBUSTION OVENS

# Sedicinoni Black



Verniciato nero - Camera di cottura sviluppata orizzontalmente - Doppia ventilazione.  
Black painted - Horizontal layout of the cooking chamber - Double ventilation fan.



Gli accessori più richiesti

The most popular accessories



Piana refrattaria aggiuntiva  
Additional refractory plate



Kit "Porchetta"



Pala/ Shovel



Portapale / Shovels kit

# Sedicinoni Country

la praticità della camera di cottura orizzontale

great ease with the ultra-wide cooking chamber



**5** anni di Garanzia  
su camera di cottura e combustione  
on baking and cooking chambers  
years warranty

**100%** Made  
in Italy

## DOTAZIONI DI SERIE

**Doppia ventilazione**, valvole fumi e vapori, termometro, timer, illuminazione interna, 2 griglie cromate, 2 teglie rettangolari, accessorio prenditeglie, attizzatoio, guanto.

## STANDARD EQUIPMENT

**Double ventilation fan**, smoke and steam valves, thermometer, timer, internal lighting, 2 chrome grilles, 2 rectangular baking pans, pan holder tool, poker, oven mitt.

Vista frontale - View from the front

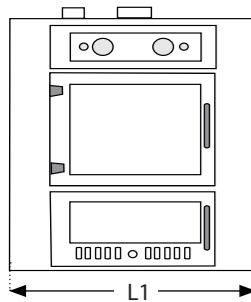

Vista laterale - View from the side

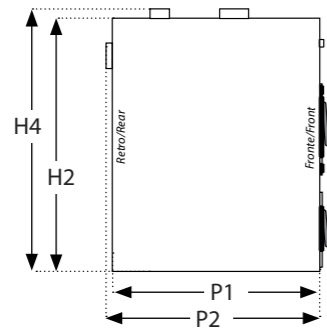

Vista dall'alto - View from the top

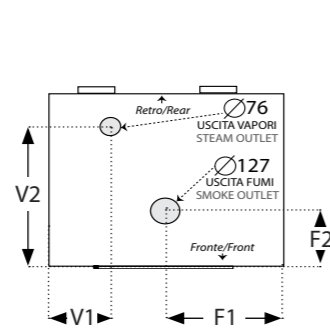

Camera di cottura - Cooking chamber

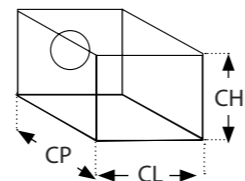

Codice modello Item code	L1	P1	P2	H2	H4	F1	F2	V1	V2	KG	CL	CP	CH	Carica legna Wood load
Sedicinoni 80iC	1005	780	820	1000	1040	502	270	335	640	200	730	630	390	3/4 Kg

Dimensioni in millimetri, peso in Kg. - Dimensions in millimeters, weight in Kg.

Principali Accessori / Main accessories	
Articolo / Item	Codice Code
Supporto fisso per forno / Special stand for oven	SW
Kit Porchetta / Kit for big roasts	GPWKIT
Piana refrattaria aggiuntiva / Additional refractory plate	PBWSC

Trovi altri accessori da pagina 74: teglie speciali, pale pane pizza, portapale, griglie e teglie aggiuntive...

More accessories starting on page 74: special pans, bread and pizza shovels, shovel holder, additional grilles and pans...

# FORNI A COMBUSTIONE SEPARATA DA INCASSO

BUILT IN SEPARATED COMBUSTION OVENS

# Sedicinoni Country



Verniciato marrone - Camera di cottura sviluppata orizzontalmente - Doppia ventilazione.  
Brown painted - Horizontal layout of the cooking chamber - Double ventilation fan.



Gli accessori più richiesti

The most popular accessories



Piana refrattaria aggiuntiva  
Additional refractory plate



Kit "Porchetta"



Pala/ Shovel



Portapale / Shovels kit

# Steel

la forza e la bellezza dell'acciaio

the strenght and the beauty of steel

**5** anni di Garanzia  
su camere di cottura e combustione  
on baking e cooking chambers  
years warranty

**100%** Made  
in Italy



## DOTAZIONI DI SERIE

Ventilazione, valvole fumi e vapori, termometro, timer, illuminazione interna, 2 griglie cromate, 1 teglia rettangolare, accessorio prenditeglie, attizzatoio, guanto.

## STANDARD EQUIPMENT

Ventilation fan, smoke and steam valves, thermometer, timer, internal lighting, 2 chrome grilles, 1 rectangular baking pan, pan holder tool, poker, oven mitt.

Vista frontale - View from the front

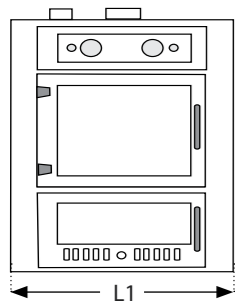

Vista laterale - View from the side

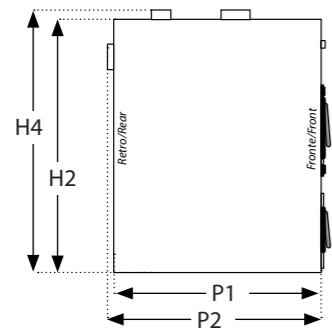

Vista dall'alto - View from the top

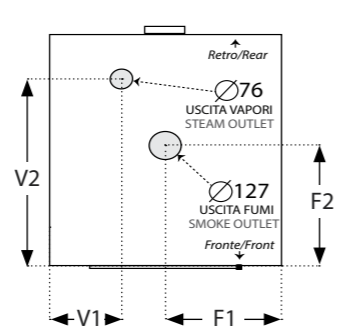

Camera di cottura - Cooking chamber

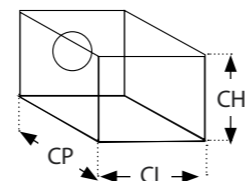

Codice modello Item code	L1	P1	P2	H2	H4	F1	F2	V1	V2	KG	CL	CP	CH	Carica legna Wood load
Steel 65i	755	775	815	980	1010	377	425	215	655	173	480	650	420	3 kg
Steel 80i	805	930	970	980	1010	402	425	245	810	200	480	800	420	3/4 kg
Steel 100i	805	1120	1160	980	1010	402	525	245	1005	248	480	1000	420	4 kg

Dimensioni in millimetri, peso in Kg. - Dimensions in millimeters, weight in Kg.

Principali Accessori / Main accessories				
Per For	Supporto fisso Special stand	Kit Porchetta Kit for big roasts	Piana refrattaria agg. Addit. refractory plate	
Steel 65i	S65	GP65KIT	PB65	
Steel 80i	S80	GP80KIT	PB80	
Steel 100i	S100	GP100KIT	PB100	

Trovi altri accessori da pagina 74:  
mensolina frontale, teglie speciali, pale pane pizza, portapale, griglie e teglie aggiuntive...

More accessories starting on page 74:  
front shelf, special pans, bread and pizza shovels, shovel holder additional grilles and pans...

# FORNI A COMBUSTIONE SEPARATA DA INCASSO

BUILT IN SEPARATED COMBUSTION OVENS

Steel



Struttura frontale acciaio inox - Vetri a specchio nelle camere di cottura e combustione.  
Stainless steel front panel - Doors with mirrored glasses.



Gli accessori più richiesti

The most popular accessories



Piana refrattaria aggiuntiva  
Additional refractory plate



Kit "Porchetta"



Teglia forata/ Perforated pan



Pala/ Shovel



Colore mod. Fiamma  
Color mod. Fiamma

Colore mod. Rame  
Color mod. Rame

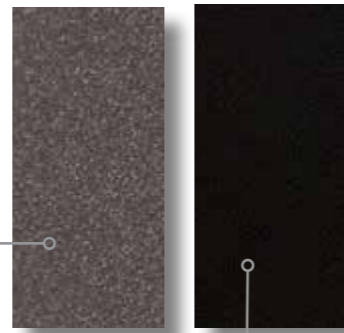

## DOTAZIONI DI SERIE

Ventilazione, valvole fumi e vapori, termometro, timer, illuminazione interna, 2 griglie cromate, 1 teglia rettangolare, accessorio prenditeglie, attizzatoio, guanto.

## STANDARD EQUIPMENT

Ventilation fan, smoke and steam valves, thermometer, timer, internal lighting, 2 chrome grilles, 1 rectangular baking pan, pan holder tool, poker, oven mitt.

**5** anni di Garanzia  
su camere di cottura e combustione  
on baking e cooking chambers  
years warranty

**100%** Made  
in Italy

Vista frontale - View from the front

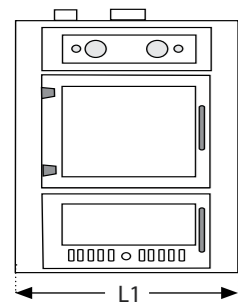

Vista laterale - View from the side

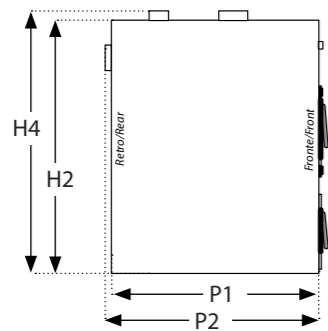

Vista dall'alto - View from the top

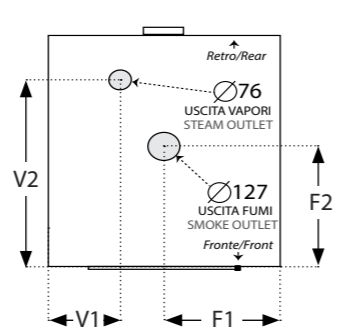

Camera di cottura - Cooking chamber

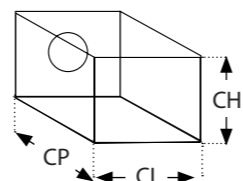

Codice modello Item code	L1	P1	P2	H2	H4	F1	F2	V1	V2	KG	CL	CP	CH	Carica legna Wood load
Fiamma 65i / Rame 65i	755	775	815	980	1010	377	425	215	655	173	480	650	420	3 kg
Fiamma 80i / Rame 80i	805	930	970	980	1010	402	425	245	810	200	480	800	420	3/4 kg
Fiamma100i / Rame 100i	805	1120	1160	980	1010	402	525	245	1005	248	480	1000	420	4 kg

Dimensioni in millimetri, peso in Kg. - Dimensions in millimeters, weight in Kg.

Principali Accessori / Main accessories				
Per For	Supporto fisso Special stand	Kit Porchetta Kit for big roasts	Piana refrattaria agg. Addit. refractory plate	
Fiamma/Rame 65i	S65	GP65KIT	PB65	
Fiamma/Rame 80i	S80	GP80KIT	PB80	
Fiamma/Rame 100i	S100	GP100KIT	PB100	

Trovi altri accessori  
da pagina 74:  
mensolina frontale,  
teglie speciali  
pale pane pizza,  
portapale,  
griglie e teglie aggiuntive...

More accessories  
starting on page 74:  
front shelf,  
special pans,  
bread and pizza shovels,  
shovel holder  
additional grilles and pans...



Struttura verniciata - Fiamma: grigio e intarsi acciaio inox; Rame: nero e intarsi rame - Vetro anche nella camera di combustione.  
Fiamma: painted grey and stainless steel finishes; Rame: painted black and copper finishes - Glass also in the combustion chamber.



Gli accessori  
più richiesti

The most popular  
accessories



Piana refrattaria aggiuntiva  
Additional refractory plate



Kit "Porchetta"



Teglia forata/ Perforated pan



Pala/ Shovel



**5** anni di Garanzia  
su camere di cottura e combustione  
on baking and cooking chambers  
years warranty

**100%** Made  
in Italy

**DOTAZIONI DI SERIE**

Ventilazione, valvole fumi e vapori, termometro, timer, illuminazione interna, 2 griglie cromate, 1 teglia rettangolare, accessorio prenditeglie, attizzatoio, guanto.

**STANDARD EQUIPMENT**

Ventilation fan, smoke and steam valves, thermometer, timer, internal lighting, 2 chrome grilles, 1 rectangular baking pan, pan holder tool, poker, oven mitt.

Vista frontale - View from the front

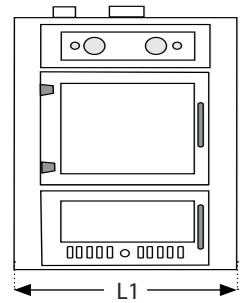

Vista laterale - View from the side

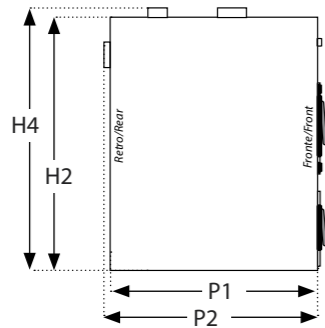

Vista dall'alto - View from the top

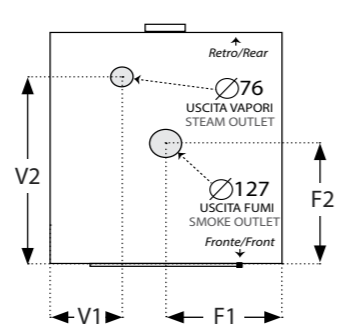

Camera di cottura - Cooking chamber

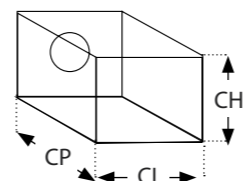

Codice modello Item code	L1	P1	P2	H2	H4	F1	F2	V1	V2	KG	CL	CP	CH	Carica legna Wood load
Effe 65i	755	775	815	980	1010	377	425	215	655	173	480	650	420	3 kg
Effe 80i	805	930	970	980	1010	402	425	245	810	200	480	800	420	3/4 kg
Effe100i	805	1120	1160	980	1010	402	525	245	1005	248	480	1000	420	4 kg

Dimensioni in millimetri, peso in Kg. - Dimensions in millimeters, weight in Kg.

Principali Accessori / Main accessories				
Per For	Supporto fisso Special stand	Kit Porchetta Kit for big roasts	Piana refrattaria agg. Addit. refractory plate	
Effe 65i	S65	GP65KIT	PB65	
Effe 80i	S80	GP80KIT	PB80	
Effe 100i	S100	GP100KIT	PB100	

Trovi altri accessori da pagina 74: mensolina frontale, teglie speciali, pale pane pizza, portapale, griglie e teglie aggiuntive...

More accessories starting on page 74: front shelf, special pans, bread and pizza shovels, shovel holder additional grilles and pans...

Struttura verniciata - Bordatura vetri in acciaio inox - Consolle strumenti con ribaltina di protezione.  
Painted - Glasses with steel frame - Control panel protected by tilting lid.



Gli accessori più richiesti

The most popular accessories



Piana refrattaria aggiuntiva  
Additional refractory plate



Kit "Porchetta"



Teglia forata/ Perforated pan



Pala/ Shovel



# Eco & Eco 50

design essenziale, alta qualità, costo contenuto

minimal design, high quality, low cost

**5** anni di Garanzia  
su camera di cottura e combustione  
on baking e cooking chambers  
years warranty

**100%** Made  
in Italy



## DOTAZIONI DI SERIE

**Eco:** Ventilazione, valvole fumi e vapori, termometro, timer, illuminazione interna, 2 griglie cromate, 1 teglia rettangolare, accessorio prenditeglie, attizzatoio, guanto.

**Eco 50:** Ventilazione, termometro, timer, illuminazione interna, 2 griglie cromate, 1 teglia, accessorio prenditeglie, attizzatoio, guanto.

## STANDARD EQUIPMENT

**Eco:** Ventilation fan, smoke and steam valves, thermometer, timer, internal lighting, 2 chrome grilles, 1 rectangular baking pan, pan holder tool, poker, oven mitt.

**Eco 50:** Ventilation fan, thermometer, timer, internal lighting, 2 chrome grilles, 1 baking pan, pan holder tool, poker, oven mitt.

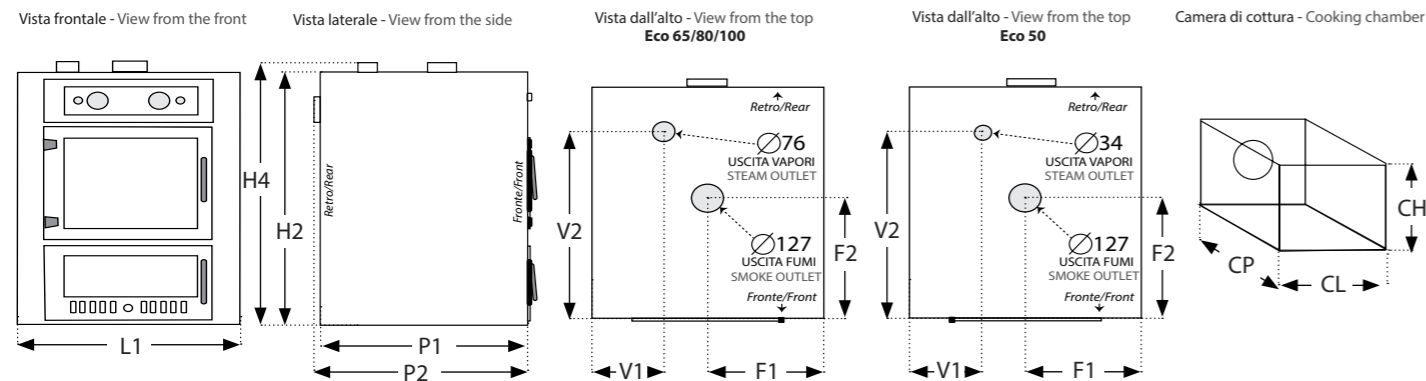

Codice modello Item code	L1	P1	P2	H2	H4	F1	F2	V1	V2	KG	CL	CP	CH	Carica legna Wood load
Eco 65i	755	775	815	980	1010	377	425	215	655	173	480	650	420	3 kg
Eco 80i	805	930	970	980	1010	402	425	245	810	200	480	800	420	3/4 kg
Eco 100i	805	1120	1160	980	1010	402	525	245	1005	248	480	1000	420	4 kg
Eco 50i	615	650	690	850	890	307	280	185	495	110	400	500	400	3 Kg

Dimensioni in millimetri, peso in Kg. - Dimensions in millimeters, weight in Kg.

Principali Accessori / Main accessories				
Per For	Supporto fisso Special stand	Kit Porchetta Kit for big roasts	Piana refrattaria agg. Addit. refractory plate	
Eco 65i	S65	GP65KIT	PB65	
Eco 80i	S80	GP80KIT	PB80	
Eco 100i	S100	GP100KIT	PB100	
Eco 50i	S50	Non disp./Not availab.	PB50	

Trovi altri accessori da pagina 74:  
mensolina frontale (\*), teglie speciali, pale pane pizza, portapale, griglie e teglie aggiuntive...

(\* escludo Eco 50

More accessories starting on page 74:  
front shelf (\*), special pans, bread and pizza shovels, shovel holder, additional grilles and pans...

(\* except Eco 50

# FORNI A COMBUSTIONE SEPARATA DA INCASSO

BUILT IN SEPARATED COMBUSTION OVENS

# Eco & Eco 50



Struttura verniciata - Consolle strumenti completa - vetro anche sulla camera di combustione.

Painted - complete instrument console - glass also on the combustion chamber.



Eco 65/80/100

Eco 50

Gli accessori più richiesti

The most popular accessories



Piana refrattaria aggiuntiva  
Additional refractory plate



Kit "Porchetta"



Teglia forata/ Perforated pan



Pala/ Shovel

**5** anni di Garanzia  
su camera di cottura e combustione  
on baking e cooking chambers  
years warranty

**100%** Made  
in Italy



camera di combustione con vetro opzionale  
combustion chamber with glass on demand

Colori del frontale  
Front panel colors

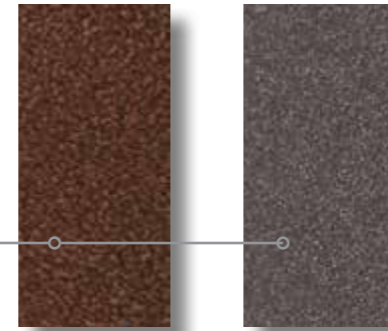

Codici colore  
Color codes

**MR**

**GL**

## DOTAZIONI DI SERIE

Ventilazione, valvole fumi e vapori, termometro, timer, illuminazione interna, 2 griglie cromate, 1 teglia, accessorio prenditeglie, attizzatoio, guanto.

## STANDARD EQUIPMENT

Ventilation fan, smoke and steam valves, thermometer, timer, internal lighting, 2 chrome grilles, 1 baking pan, pan holder tool, poker, oven mitt.

Vista frontale - View from the front

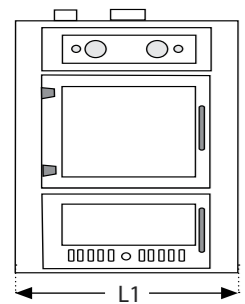

Vista laterale - View from the side

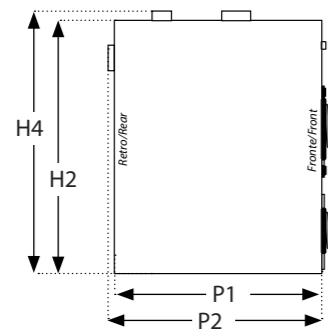

Vista dall'alto - View from the top

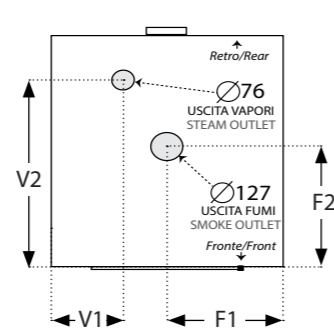

Camera di cottura - Cooking chamber

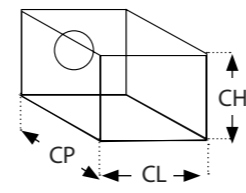

Codice modello Item code	Colore Color	L1	P1	P2	H2	H4	F1	F2	V1	V2	KG	CL	CP	CH	Carica legna Wood load
GAC65iM	Marrone brown	755	775	815	980	1010	377	425	215	655	173	480	650	420	3 kg
GAC65iG	Grigio Lava Lava Grey														
GAC80iM	Marrone brown	805	930	970	980	1010	402	425	245	810	200	480	800	420	3/4 kg
GAC80iG	Grigio Lava Lava Grey														

Dimensioni in millimetri, peso in Kg. - Dimensions in millimeters, weight in Kg.

Principali Accessori / Main accessories					
Per For	Supporto fisso Special stand	Kit Porchetta Kit for big roasts	Vetro Camera Combustione Glass on combustion chamber		
GAC 65i	S65	GP65KIT	GAVTCC		
GAC 80i	S80	GP80KIT	GAVTCC		

Trovi altri accessori  
da pagina 74:  
mensolina frontale,  
teglie speciali  
pale pane pizza,  
portapale,  
griglie e teglie aggiuntive...

More accessories  
starting on page 74:  
front shelf,  
special pans,  
bread and pizza shovels,  
shovel holder  
additional grilles and pans...

Frontale disponibile in due colorazioni - Sportello camera di combustione disponibile anche con vetro.  
Frontal panel available in two colors - Door of the combustion chamber available with or without glass.



Gli accessori  
più richiesti

The most popular  
accessories



Piana refrattaria aggiuntiva  
Additional refractory plate



Kit "Porchetta"



Teglia forata/ Perforated pan



Pala/ Shovel

# Quattrostagioni

ogni stagione é buona; inforni e cuoci dalla cucina o dal giardino, secondo il tempo che fa o come ti va  
work from the kitchen or from the garden, depending on the weather or as you wish

**5** anni di Garanzia  
su camere di cottura e combustione  
on baking and cooking chambers  
years warranty

**100%** Made  
in Italy

1 forno 2 facciate 4 stagioni  
**1 x 2 = 4**  
1 oven 2 fronts 4 seasons

Utilizza i frontali dei modelli da incasso ECO e STEEL, cioè: entrambi i Frontali ECO oppure un frontale ECO ed uno STEEL per abbinarlo al meglio con gli ambienti.

For this oven are used the front types of the ovens "ECO" and "STEEL", as follow:  
ECO + ECO or ECO + STEEL.

## DOTAZIONI DI SERIE

Valvole fumi e vapori, termometro, timer, illuminazione interna, 2 griglie cromate, 1 teglia rettangolare, accessorio prenditeglie, attizzatoio, guanto.

## STANDARD EQUIPMENT

Smoke and steam valves, thermometer, timer, internal lighting, 2 chrome grilles, 1 rectangular baking pan, pan holder tool, poker, oven mitt.

Vista frontale - View from the front

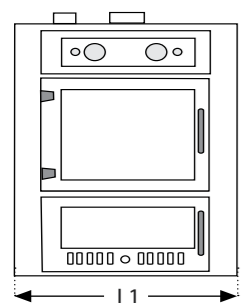

Vista laterale - View from the side

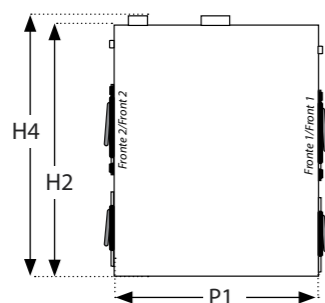

Vista dall'alto - View from the top

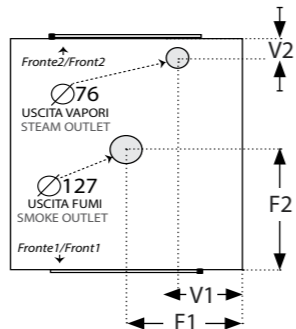

Camera di cottura - Cooking chamber

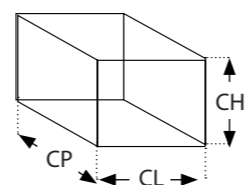

Codice modello Item code	Tipo frontali type of fronts	L1	P1	H2	H4	F1	F2	V1	V2	KG	CL	CP	CH	Carica legna Wood load
Quattrostagioni EE	"ECO" + "ECO"	755	800	980	1010	377	400	263	90	205	480	750	420	3 kg
Quattrostagioni ES	"ECO"+ "STEEL"	755	800	980	1010	377	400	263	90	205	480	750	420	3 kg

Dimensioni in millimetri, peso in Kg. - Dimensions in millimeters, weight in Kg.

Principali Accessori / Main accessories					
Per For	Supporto fisso Special stand	Kit Porchetta Kit for big roasts	Piana refrattaria agg. Addit. refractory plate		
Quattrostagioni	S65	GP65KIT	PB65		

Trovi altri accessori da pagina 74:  
teglie speciali  
pale pane pizza,  
portapale,  
griglie e teglie aggiuntive...  
(nota: per gli accessori far riferimento ai forni da 65)

More accessories starting on page 74:  
special pans,  
bread and pizza shovels,  
shovel holder  
additional grilles and pans...  
(note: for accessories refer to ovens of 65)

# FORNI A COMBUSTIONE SEPARATA DA INCASSO

BUILT IN SEPARATED COMBUSTION OVENS

# Quattrostagioni



Forno bifacciale che si incassa nel muro perimetrale che divide la cucina dalla veranda o dal giardino e lo usi in qualsiasi stagione.  
Bifrontal oven to be mounted inside the wall between kitchen and garden or porch; so that you can use it in any season.



visto da fuori / outdoor view

visto da dentro / indoor view

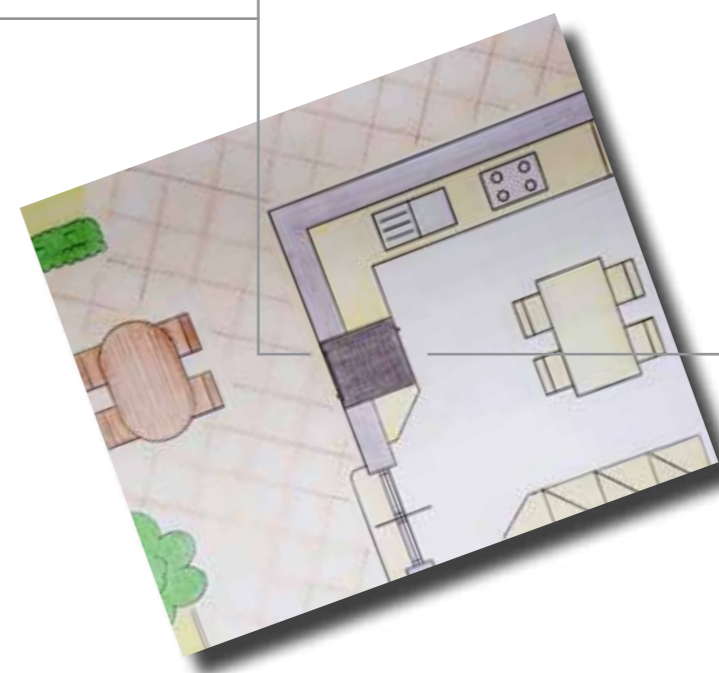

Puoi caricare la legna dall'esterno per non sporcare e cucinare dall'interno.

Puoi preparare i cibi ed infornarli dall'interno e poi sfornare e servirli dall'esterno.

You can load the wood from the outside so as not to dirty and cook from the inside.

You can prepare the food and bake it from the inside and then take it out and serve it from the outside.



**FORNI A COMBUSTIONE DIRETTA  
DA ESTERNO**

**OUTDOOR  
DIRECT COMBUSTION OVENS**

Più trecento	54-55
Nonna Luisa	56-57
Benni	58-59
Campagnolo	60-61
Mino	61-62

# Più trecento

il grande forno per insaziabili buongustai

the great oven for insatiable gourmets



## Pizza pronta in 2 minuti

Accensione e riscaldamento in 20 minuti, poi solo altri 2 per cuocere una pizza



## Pizza ready in 2 minutes

20 minute for ignition and heating, then just 2 more minutes to bake a pizza

### DOTAZIONI DI SERIE

Termometro, attizzatoio, comignolo, braciere, guanto.

### STANDARD EQUIPMENT

Thermometer, poker, chimney, brazier, oven mitt.



Vista frontale - View from the front

Vista laterale - View from the side

Camera di cottura - Cooking chamber

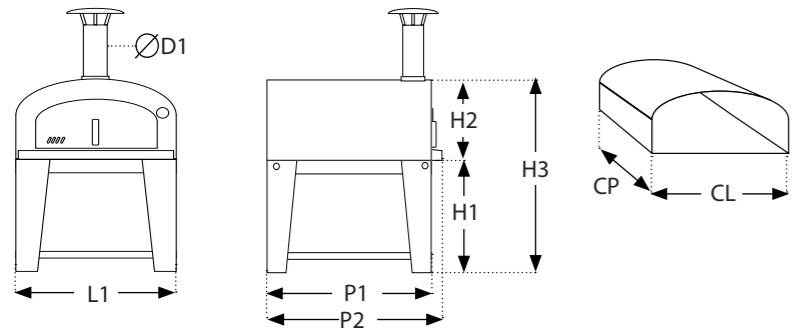

la versione a Gas non può essere fornita senza carrello che alloggia i controlli e sostiene il bruciatore



the gas version cannot be supplied without cart that houses the controls and supports the burner

Codice	Alimentaz. Fuel	Descrizione Info	L1	P1	P2	H1	H2	H3	KG	D1	CL	CP
FPTCV	Legna/Wood	Forno + carrello / Oven + cart	990	1085	1135	905	520	1425	197	150	800	900
FPT	Legna/Wood	Solo forno / Only oven	990	1085	1135		520		158,5	150	800	900
FPTCVG-B1E	Gas UE	Forno + carrello / Oven + cart	990	1085	1135	905	520	1425	230	150	800	900
FPTCVG-B1U	Gas USA	Forno + carrello / Oven + cart	990	1085	1135	905	520	1425	230	150	800	900

Dimensioni in millimetri, peso in Kg. - Dimensions in millimeters, weight in Kg.

### Principali Accessori / Main accessories

Codice Code	Articolo Item
CFPV	Carrello verniciato nero / Black painted cart
PAFP	Piano laterale / Side shelf
CCFD	Controcappa frontale / Front Counter hood
ACK06+PPL6E	Kit 6 Pale + Portapale / Kit 6 shovels + shovel holder
CPFDP	Cappottina impermeabile / Waterproof cover

La versione a legna può essere trasformata a gas con l'acquisto dell'apposito kit

Trovi altri accessori da pagina 74

The Gas version can be transformed into wood one with the purchase of the appropriate kit

More accessories starting on page 74

# FORNI A COMBUSTIONE DIRETTA DA ESTERNO

OUTDOOR DIRECT COMBUSTION OVENS

# Più trecento



Frontali in acciaio Inox - Copertura verniciata colore rosso - Carrello indipendente verniciato nero - Grande camera di cottura.  
Front parts in stainless steel - Crankcase red painted - Black painted Stand-alone cart - Very wide cooking chamber.



La "controcappa" frontale (opzionale) è progettata per il contenimento di fumi e vapori in caso di installazione in ambienti chiusi (ordinabile solo insieme al forno, non applicabile successivamente).

The front "counter hood" (optional) is designed to contain smokes and steams in case of installation in closed environments (to be ordered at the same time as the oven, it cannot be applied later).

Completa il tuo forno con il kit strumenti "SEI" e il portapale

Complete your oven with the tool kit "SEI" and the shovel holder

### Alimentazione a legna - Wood fueled



### Alimentazione a Gas - Gas fueled



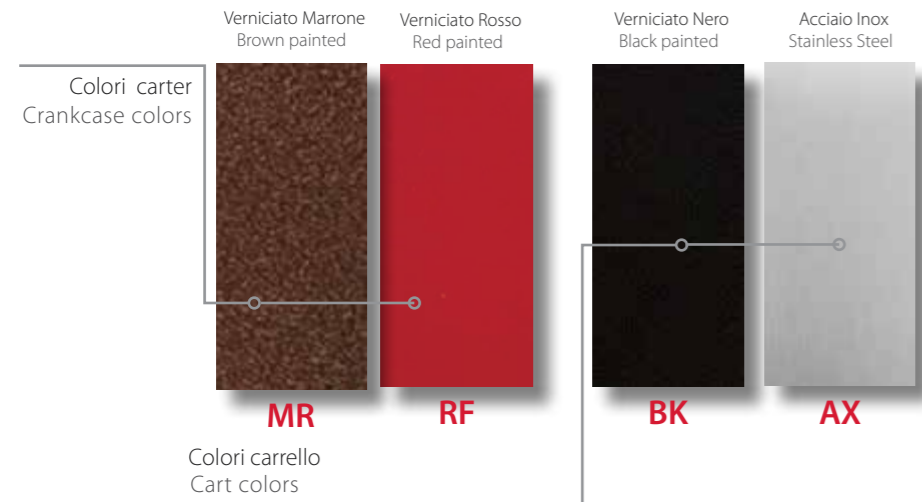

## Pizza pronta in 2 minuti

Accensione e riscaldamento in 20 minuti, poi solo altri 2 per cuocere una pizza



## Pizza ready in 2 minutes

20 minute for ignition and heating, then just 2 more minutes to bake a pizza

### DOTAZIONI DI SERIE

Termometro, attizzatoio, comignolo, braciere, guanto.

### STANDARD EQUIPMENT

Thermometer, poker, chimney, brazier, oven mitt.



Vista frontale - View from the front

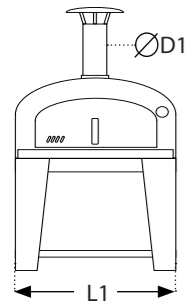

Vista laterale - View from the side

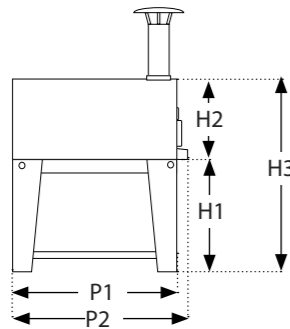

Camera di cottura - Cooking chamber

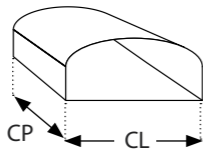

La "controcappa" frontale (opzionale) è progettata per il contenimento di fumi e vapori in caso di installazione in ambienti chiusi

The front "counter-hood" (optional) is designed for the containment of smokes and steams in case of installation in closed environments



*Ordinabile solo contestualmente al forno; non può essere applicata successivamente.*

*To be ordered only at the same time as the oven; it cannot be applied later.*

Codice	Alimentaz. Fuel	Descrizione Info	L1	P1	P2	H1	H2	H3	KG	D1	CL	CP
FNLRCV	Legna/Wood	Forno + carrello verniciato Oven + painted cart	990	785	835	905	520	1425	136,5	150	800	600
FNLRCX	Legna/Wood	Forno + carrello Inox Oven + Stainless steel cart	990	785	835	905	520	1425	136,5	150	800	600
FNLR	Legna/Wood	Solo forno / Oven only	990	785	835		520		108,5	150	800	600
FNLRCVG-B1E	Gas UE	Forno + carrello verniciato Oven + painted cart	990	785	835	905	520	1425	169,0	150	800	600
FNLRCVG-B1U	Gas USA	Forno + carrello verniciato Oven + painted cart	990	785	835	905	520	1425	169,0	150	800	600

Dimensioni in millimetri, peso in Kg. - Dimensions in millimeters, weight in Kg.

#### Principali Accessori / Main accessories

Codice Code	Articolo Item
CFNV	Solo Carrello verniciato nero / Only black painted cart
CFNX	Solo Carrello Inox / Only stainless steel cart
PAFN	Piano laterale / Side shelf
CCFD	Controcappa frontale / Front Counter hood
CPFND	Cappottina impermeabile / Waterproof cover

La versione a Gas può essere trasformata a legna con l'acquisto dell'apposito kit

The Gas version can be transformed into wood one with the purchase of the appropriate kit

Altri accessori da pagina 74

More optional equipments starting on page 74



Frontale in acciaio Inox - Carter di copertura verniciato rosso o marrone - Carrello indipendente verniciato nero o in acciaio.  
Front panel in stainless steel - Crankcase red or brown painted - Stand-alone cart black painted or made in stainless steel.



La versione a gas di "Nonna Luisa". (Questa versione non può essere fornita senza carrello che alloggia i controlli e sostiene il bruciatore)

The gas version of "Nonna Luisa". (This version cannot be supplied without cart that houses the controls and supports the burner)

#### Alimentazione a Gas - Gas fueled



#### Alimentazione a legna - Wood fueled



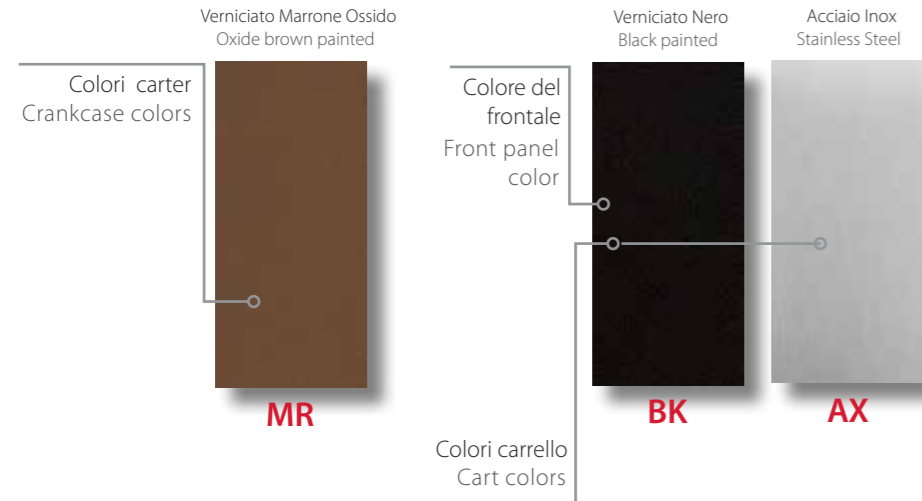

## Pizza pronta in 2 minuti

Accensione e riscaldamento in 20 minuti, poi solo altri 2 per cuocere una pizza



## Pizza ready in 2 minutes

20 minute for ignition and heating, then just 2 more minutes to bake a pizza

### DOTAZIONI DI SERIE

Termometro, attizzatoio, comignolo con valvola, braciere, guanto.

### STANDARD EQUIPMENT

Thermometer, poker, chimney with valve, brazier, oven mitt.



Vista frontale - View from the front    Vista laterale - View from the side    Camera di cottura - Cooking chamber

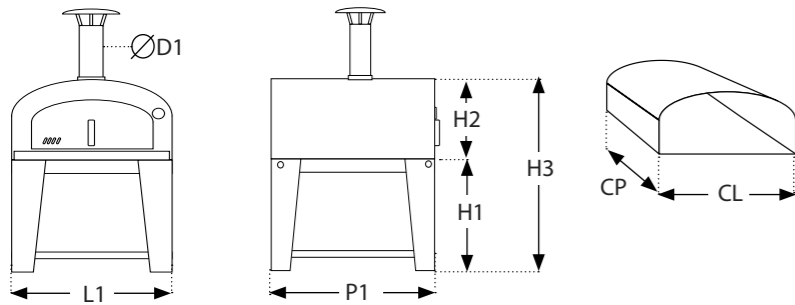

Codice	Alimentaz. Fuel	Descrizione Info	L1	P1	H1	H2	H3	KG	D1	CL	CP
FBERCV	Legna/Wood	Forno + carrello verniciato Oven + painted cart	985	840	905	500	1405	126	130	800	600
FBERCX	Legna/Wood	Forno + carrello Inox Oven + Stainless steel cart	985	840	905	500	1405	126	130	800	600
FBER	Legna/Wood	Solo forno / Oven only	985	840		500		98	130	800	600

Dimensioni in millimetri, peso in Kg. - Dimensions in millimeters, weight in Kg.

#### Principali Accessori / Main accessories

Codice Code	Articolo Item
CFNV	Solo Carrello verniciato nero / Only black painted cart
CFNX	Solo Carrello Inox / Only stainless steel cart
PAFC	Piano laterale / Side shelf
CPFDNL	Cappottina impermeabile / Waterproof cover
CMUM+CMUME	Carrello Cucina modulare con estensione/Modular kitchen cart with extension

Altri accessori da pagina 74

More optional equipments starting on page 74

Carter di copertura verniciato marrone ossido- Frontale verniciato nero - Carrello indipendente verniciato nero.  
Crankcase Oxide brown painted - Front panel black painted - Stand-alone cart black painted.



Puoi anche acquistarlo con il Carrello cucina + estensione anziché quello standard  
You can also buy it with the kitchen cart + extension instead of the standard one

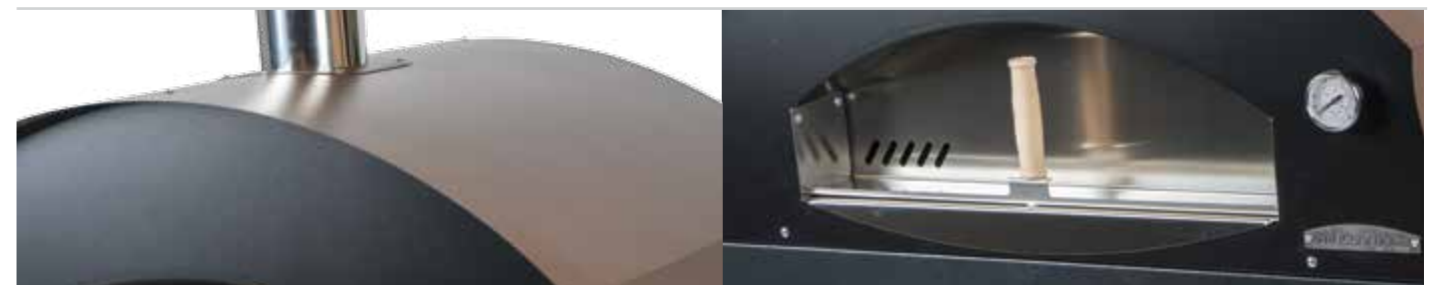

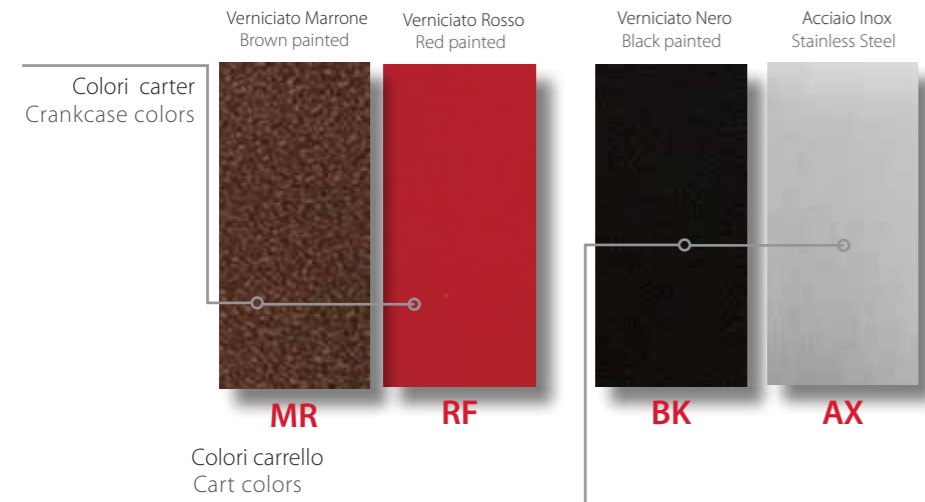

## Pizza pronta in 2 minuti

Accensione e riscaldamento in 20 minuti, poi solo altri 2 per cuocere una pizza



## Pizza ready in 2 minutes

20 minute for ignition and heating, then just 2 more minutes to bake a pizza

### DOTAZIONI DI SERIE

Termometro, attizzatoio, comignolo, braciere, guanto.

### STANDARD EQUIPMENT

Thermometer, poker, chimney, brazier, oven mitt.

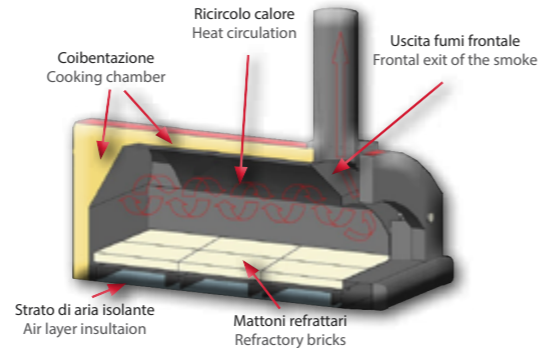
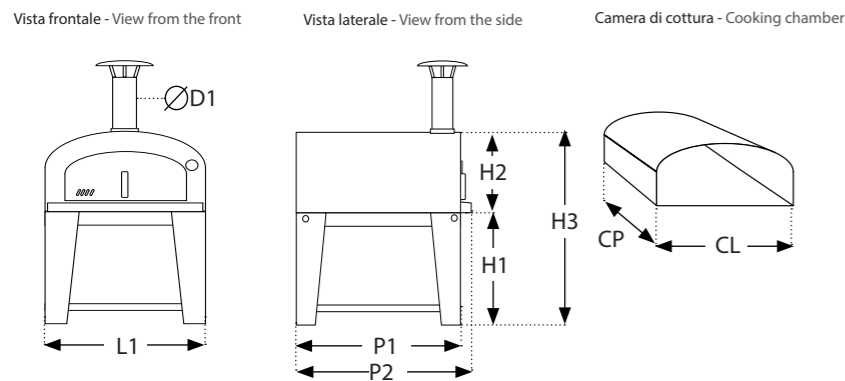

Codice	Alimentaz. Fuel	Descrizione Info	L1	P1	P2	H1	H2	H3	KG	D1	CL	CP
FCARCV	Legna/Wood	Forno + carrello verniciato / Oven + painted cart	790	690	740	800	520	1320	96,5	150	600	500
FCARCX	Legna/Wood	Forno + carrello Inox / Oven + Stainless steel cart	790	690	740	800	520	1320	96,5	150	600	500
FCAR	Legna/Wood	Solo forno / Oven only	790	690	740		520		77	150	600	500

Dimensioni in millimetri, peso in Kg. - Dimensions in millimeters, weight in Kg.

Principali Accessori / Main accessories	
Codice Code	Articolo Item
CFCV	Solo Carrello verniciato nero / Only black painted cart
CFCX	Solo Carrello Inox / Only stainless steel cart
PAFC	Piano laterale / side shelf
CMUM+CMUME+ACK04C	Carrello cucina + estensione + kit 4strumenti ACK04C / Modular kitchen cart + extension + kit of four tools ACK04C

Altri accessori da pagina 74 / More optional equipments starting on page 74



Carter di copertura verniciato rosso o marrone - Frontale in acciaio Inox - Carrello indipendente verniciato nero o in acciaio.  
Crankcase red or brown painted - Front panel in stainless steel - Stand-alone cart black painted or made in stainless steel.



Kit strumenti "QUATTRO" e portatile, per cucinare al meglio  
Tool kit "QUATTRO" and shovel holder, very useful equipments





# Mino

Il forno facile da portare ovunque vuoi

The handy oven to take wherever you want

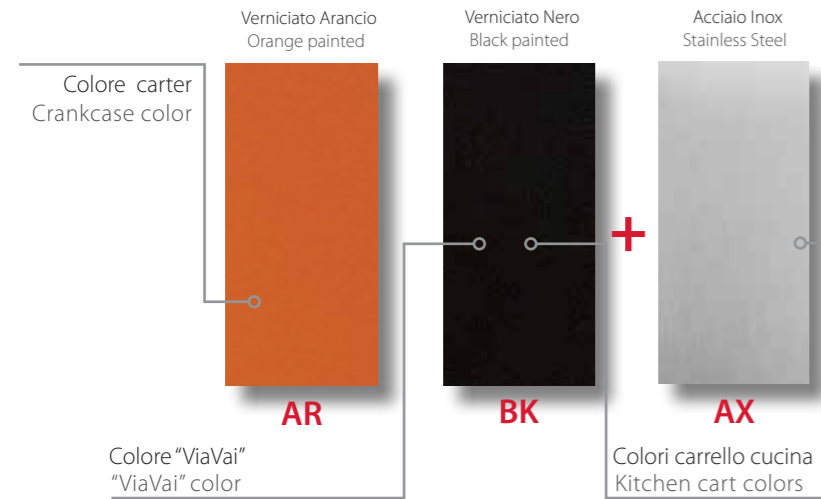

Pizza pronta in 2 minuti

Accensione e riscaldamento in 20 minuti, poi solo altri 2 per cuocere una pizza

## DOTAZIONI DI SERIE

Termometro, comignolo con valvola, braciere, guanto.

## STANDARD EQUIPMENT

Thermometer, chimney with valve, brazier, oven mitt.



Pizza ready in 2 minutes

20 minute for ignition and heating, then just 2 more minutes to bake a pizza

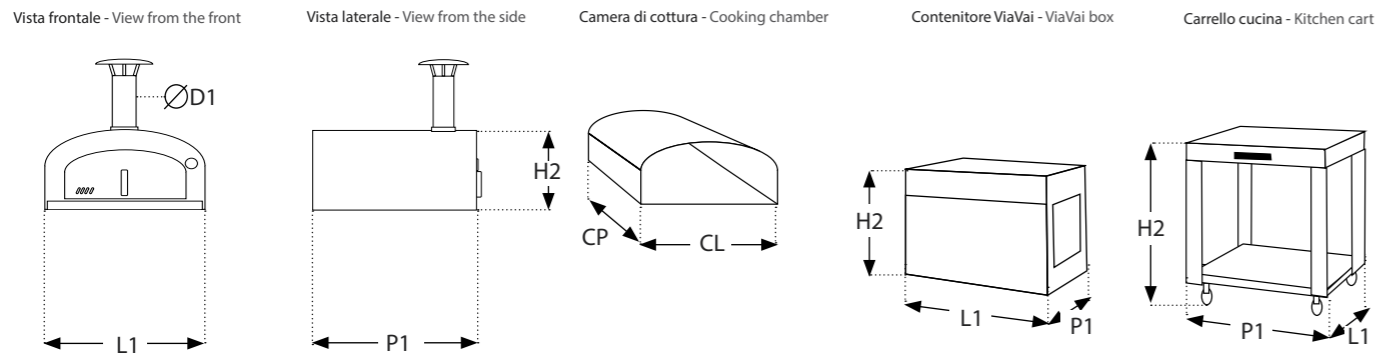

Codice Code	Descrizione Info	Alimentaz. Fuel	L1	P1	H1	H2	H3	KG	D1	CL	CP
FMIR	Forno / Oven	Legna/Wood	705	485		315		34	100	600	400
CCOVV	VIAVAI contenitore attrezzato per trasporto forno VIAVAI equipped container to transport the oven		750	570		550		25			
CMUM	Carrello cucina modulare / Modular kitchen cart		705	775		900		28			
CMUME	Prolunga carrello cucina / Extension for kitchen cart		705	775		900		33			

Dimensioni in millimetri, peso in Kg. - Dimensions in millimeters, weight in Kg.

Principali Accessori / Main accessories			
Codice Code	Articolo Item	Dimensioni Dimensions	
ACK04C	Kit 4 strumenti per Carrello cucina CMUM Kit 4 tool for kitchen cart CMUM		

Altri accessori da pagina 74

More optional equipments starting on page 74

# FORNI A COMBUSTIONE DIRETTA DA ESTERNO

OUTDOOR DIRECT COMBUSTION OVENS

# Mino



Carter di copertura verniciato arancione - Frontale verniciato nero - Carrello cucina multiuso verniciato nero, top acciaio.  
Crankcase orange painted - Front panel black painted - Multipurpose Kitchen cart black painted with stainless steel top.

Carrello cucina modulare multiuso con piano in acciaio Inox

Multi-purpose modular kitchen cart with stainless steel top



Carrello cucina con estensione  
Kitchen cart with extension



**ViaVai** il contenitore per portare ovunque il tuo Mino  
your Mino everywhere

**Il set da viaggio per il tuo Mino** The travel set for your Mino

Un contenitore per trasportare il forno che funge anche da supporto, con lo sportello che diventa un piano di servizio; completo degli strumenti essenziali per cucinare dove vuoi:

- pala teglia multiuso
- palino tondo,
- spazzola,
- Paletta per ceneri

A container to transport the oven that also acts as a stand, with the door that becomes a service surface; complete of the essential tools for cooking wherever you want:

- multipurpose plate,
- small round shovel,
- brush for ashes,
- ash shovel.

"ViaVai" diventa supporto per il forno  
"ViaVai" becomes a stand for the oven

Lo sportello diventa mensola di lavoro  
The door becomes a work shelf



**BARBECUE STAND ALONE  
BARBECUE PER FORNI**

---

**STAND ALONE BARBECUES  
BARBECUES FOR OVEN**

**STAND-ALONE**

Easy Up	66-67
Wood Up	68-69
Maxi	70-71
Falò Solo	72-73

**PER FORNI - FOR OVENS**

Falò	74-75
Cassetto BBQ	74-75

# Easy Up

il piccolo dalle grandi prestazioni

Small barbecue, great performances



Il sistema "Sali e scendi" della griglia  
The "Up and down" system to regulate the height of the grid

L'accenditore per carbonella (opzionale)  
the charcoal fire starter (optional)

## DOTAZIONI DI SERIE

Griglia con sistema "Sali e Scendi"

## STANDARD EQUIPMENT

Grid with "up and down" system

**100%** Made in Italy

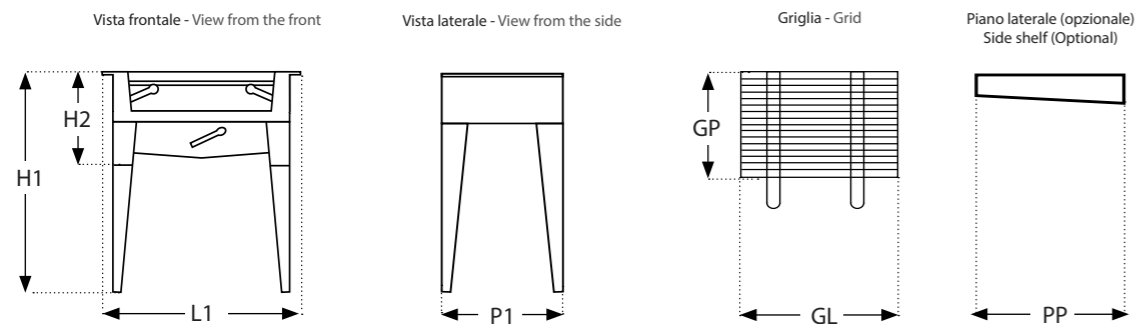

Code Code	Descrizione Info	Alimentazione Fuel	L1	P1	H1	H2	KG	GL	GP	PP
EASYUP	Barbecue Easy Up senza piani laterali e Accenditore Easy Up barbecue, without side shelves and charcoal fire starter	Carbonella Charcoal	740	450	1010	370	50	640	400	300

*Dimensioni in millimetri, peso in Kg. - Dimensions in millimeters, weight in Kg.*

Principali Accessori / Main accessories	
Code Code	Articolo Item
GBX65X	Supplemento x griglia Inox / Surcharge for Inox grid
PBV	Coppia piani laterali verniciati / Couple of painted side shelves
ACB	Accenditore carbonella (verniciato) / Charcola fire starter (painted)
GB65	Griglia aggiuntiva cromata/ Additional chrome grid
GB65X	Griglia aggiuntiva Inox/ Additional Inox grid
CPBBEU	Cappottina impermeabile / Waterproof cover

Altri accessori da pagina 74

More optional equipments starting on page 74

# BARBECUE INDIPENDENTI

STAND ALONE BARBECUES

# Easy Up



Barbecue a carbonella da giardino verniciato, con sistema "Saliscendi" completo di griglia.  
Painted charcoal barbecue for garden, with "Ups and downs" system complete with grid.



Easy Up grazie alle gambe smontabili può essere trasformato in versione da appoggio

Easy Up thanks to the removable legs can be transformed into countertop version

Easy Up con sistema "saliscendi" (i piani laterali e l'accenditore sono opzionali)

Easy Up with the "Up and down" system (the side shelves and the charcoal fire starter are sold as optional)

Gli accessori più richiesti

The most popular accessories



Cappottina/Cover



Piani laterali/Side Shelves

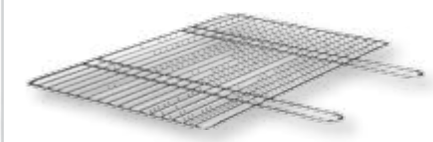

Griglia supplementare inox / Additional Inox grid

# Wood Up

il piccolo ma versatile dalle grandi prestazioni

Small but versatile barbecue for great performances



## DOTAZIONI DI SERIE

Griglia con sistema "Sali e Scendi", Braciere brucialegna posteriore

## STANDARD EQUIPMENT

Grid with "up and down" system, rear wood brazier

**100%** Made in Italy

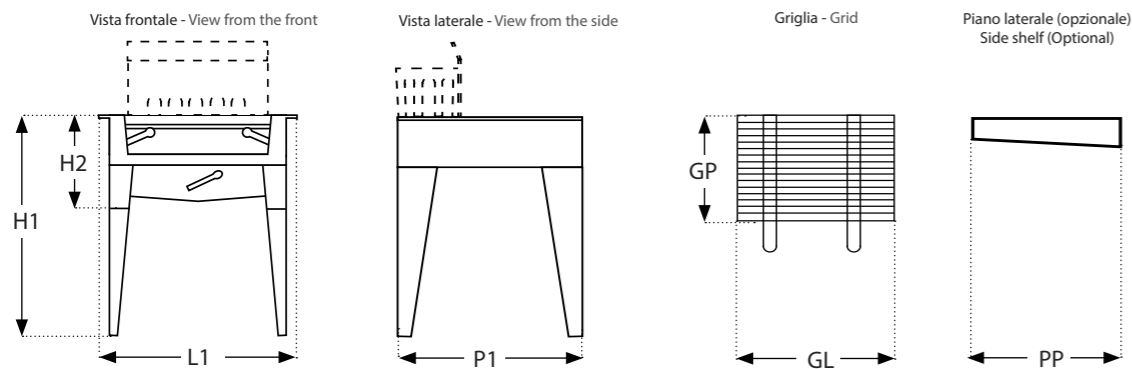

Codice Code	Descrizione Info	Alimentazione Fuel	L1	P1	H1	H2	KG	GL	GP	PP
WOODUP	Wood Up senza piani laterali con brucialegna Easy Up barbecue, with wood Brazier	Legna\Carbonella Wood\Charcoal	690	750	1010	370	55	640	400	300

*Dimensioni in millimetri, peso in Kg. - Dimensions in millimeters, weight in Kg.*

Principali Accessori / Main accessories	
Codice Code	Articolo Item
GBX65X	Supplemento x griglia Inox / Surcharge for Inox grid
PBV	Coppia piani laterali verniciati / Couple of painted side shelves
GB65	Griglia aggiuntiva cromata/ Additional chrome grid
GB65X	Griglia aggiuntiva Inox/ Additional Inox grid

Altri accessori da pagina 74

More optional equipments starting on page 74

BARBECUE INDIPENDENTI  
STAND ALONE BARBECUES

# Wood Up



Barbecue a legna o carbonella da giardino verniciato, con sistema "Saliscendi" completo di griglia.  
Painted wood and charcoal barbecue for garden, with "Ups and downs" system complete with grid.



Wood Up grazie alle gambe smontabili può essere trasformato in versione da appoggio

Wood Up thanks to the removable legs can be transformed into countertop version



Wood Up con sistema "saliscendi" (i piani laterali sono opzionali)

Wood Up with the "Up and down" system (the side shelves are sold as optional)

Gli accessori più richiesti

The most popular accessories



Strumenti/Tools



Piani laterali /Side Shelves

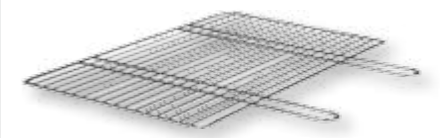

Griglia supplementare inox / Additional Inox grid

# Maxi

fantastico anche per agriturismi e ristoranti

fantastic for farmhouses and restaurants too

BARBECUE INDIPENDENTI  
STAND ALONE BARBECUES

Maxi



100% Made in Italy

Il cassetto raccogli cenere  
The ash tray

Il braciere posteriore per ricavare carbone dalla legna  
The rear brazier to obtain coal from wood



## DOTAZIONI DI SERIE

Braciere posteriore per legna, 1 griglia, Cassetto raccogli cenere, 2 piani laterali estraibili, ruote posteriori, manici anteriori estraibili

## STANDARD EQUIPMENT

Rear burner for wood, 1 grill, ash tray, 2 lateral retractable shelves, rear wheels, extractable front handles

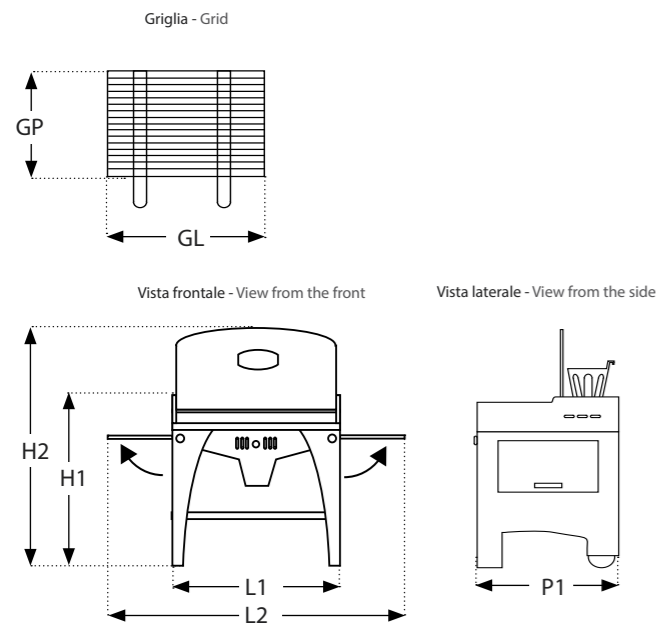

Codice Code	Descrizione Info	Alimentazione Fuel	L1	L2	P1	H1	H2	KG	GL	GP
MAXI	Barbecue MAXI con 2 piani laterali a scomparsa Barbecue with 2 retractable side shelves	Legna o carbonella Wood or charcoal	840	1400	810	950	1350	70	790	400

Dimensioni in millimetri, peso in Kg. - Dimensions in millimeters, weight in Kg.

Principali Accessori / Main accessories	
Codice Code	Articolo Item
GBX80X	Supplemento x griglia Inox / Surcharge for Inox grid
ACF	Accenditore carbonella (verniciato) / Charcola fire starter (painted)
GB80	Griglia aggiuntiva cromata / Additional chrome grid
GB80X	Griglia aggiuntiva Inox / Additional Inox grid
CPBBMX	Cappottina impermeabile / Waterproof cover

Altri accessori da pagina 74

More optional equipments starting on page 74

Robustissimo semiprofessionale - Braciere posteriore per produrre carbone dalla legna - Mensole laterali a scomparsa.  
Very robust semi-professional barbecues - Rear brazier to generate coal from wood - Retractable side shelves.



Gli accessori più richiesti

The most popular accessories



Cappottina/Cover



Accenditore carbone/Charcoal fire starter



Griglia supplementare Inox / Additional grid in Inox



Il braciere per ricavare carbone dalla legna

The brazier to obtain coal from wood



## DOTAZIONI DI SERIE

**Falò Solo:** Braciere per legna, 1 griglia con sistema "Sali e Scendi", cassetto raccogli cenere, tetto verniciato, comignolo antiventto,

## STANDARD EQUIPMENT

**Falò Solo:** Burner for wood, 1 grid with "up and down" system, ash tray, varnished roof, windproof chimney.

Il supporto per alloggiare paletta e spargibrace

The support to house the shovel and the spreader

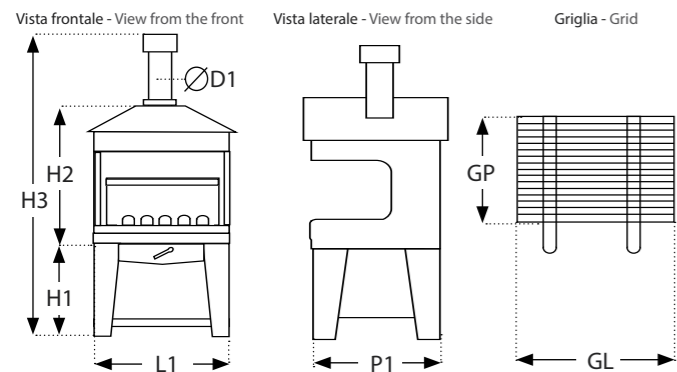

Codice Code	Descrizione Info	Alimentazione Fuel	L1	P1	H1	H2	H3	KG	GL	GP	D1
BEFS	Barbecue Stand alone, tetto verniciato Stand alone barbecue with painted roof	Legna o carbonella Wood or charcoal	780	755	750	820	2200	70	640	400	130

Dimensioni in millimetri, peso in Kg. - Dimensions in millimeters, weight in Kg.

Principali Accessori / Main accessories		
Codice Code	Per For	Articolo Item
BTX	Supplemento per tetto Inox Surcharge for roof made in stainless steel	
GBX65X	Supplemento per griglia Inox Surcharge for grid made in stainless steel	
PBV	Coppia piani laterali verniciati Couple of painted side shelves	

Altri accessori da pagina 74

More optional equipments starting on page 74



**Robusto, funzionale - Con braciere per produrre carbone dalla legna - Sistema di regolazione dell'altezza della griglia.**  
**Sturdy, functional - With brazier to produce charcoal from wood - Grid height adjustment system.**

i piani laterali (opzionali) rendono ancora più completa questa postazione di cottura

The side shelves (optional) make this cooking station even more complete

Il sistema "saliscendi" della griglia permette di regolare la sua distanza dalla brace

The "Up and down" system of the grill allows you to adjust its distance from the embers



Gli accessori più richiesti

The most popular accessories



Strumenti/Tools



Piani laterali /Side Shelves

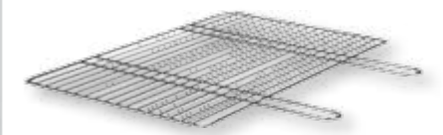

Griglia supplementare inox / Additional Inox grid

## Cassetto BBQ

Applicabile a tutti i forni da 80 da esterno; trasforma la camera di combustione in un barbecue

It can be mounted on all outdoor ovens type 80, and transforms the combustion chamber into a barbecue



Codice Code	Descrizione Info	Alimentazione Fuel	L1	P1	H1	KG	GL	GP	D1
BCF	CASSETTO BBQ Barbecue estraibile per forni da 80 Pull out BBQ for ovens type 80	Legna o carbonella Wood or charcoal					480	390	

Dimensioni in millimetri, peso in Kg. - Dimensions in millimeters, weight in Kg.

## DOTAZIONI DI SERIE

**Falò:** Braciare per legna, 1 griglia con sistema "Sali e Scendi", cassetto raccogli cenere, tetto verniciato, comignolo antivento.  
**Cassetto BBQ:** 1 griglia

## STANDARD EQUIPMENT

**Falò:** Burner for wood, 1 grid with "up and down" system, ash tray, varnished roof, windproof chimney.  
**Cassetto BBQ:** 1 grid



Vista frontale - View from the front    Vista laterale - View from the side    Griglia - Grid

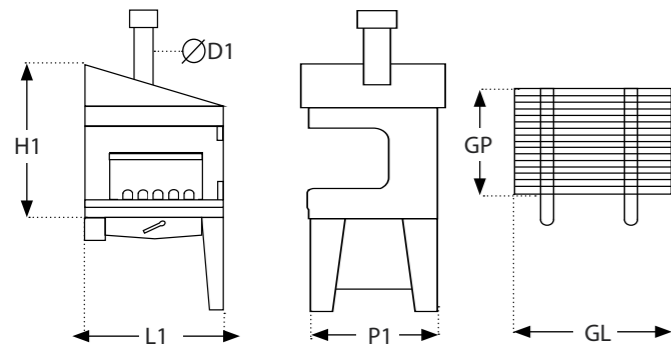

Codice Code	Descrizione Info	Alimentazione Fuel	L1	P1	H1	KG	GL	GP	D1
BEF	Barbecue laterale FALÒ, tetto verniciato Side barbecue FALÒ for oven with painted roof	Legna o carbonella Wood or charcoal	740	930	950	70	640	400	130

Dimensioni in millimetri, peso in Kg. - Dimensions in millimeters, weight in Kg.

### Principali Accessori / Main accessories

Codice Code	Per For	Articolo Item
BTX	Falò	Supplemento per tetto Inox Surcharge for roof made in stainless steel
GBX65X	Falò	Supplemento per griglia Inox Surcharge for grid made in stainless steel

Altri accessori da pagina 74

More optional equipments starting on page 74



Due soluzioni per trasformare il forno in una postazione di cottura completa.

Two solutions to transform the oven into a complete cooking station.



## Falò

Modello ad accesso frontale alimentato a legna o carbone per tutti i forni da esterno escluso modello 50

It's a front access barbecue powered by wood or charcoal, for all outdoor ovens except type 50

Con sistema "saliscendi" della griglia  
With the "Up and down" system of the grid

## ACCESSORI E RICAMBI

### OPTIONAL EQUIPMENTS SPARE PARTS

Accessori / Optional equipments	78-85
Ricambi / Spare parts	86-90
Tabella colori / Color chart	91

#### LEGENDA DEI SIMBOLI / MEANING OF SYMBOLS

- ES** = Per forni da esterno / For outdoor ovens
- IS** = Per forni da incasso / For built-in ovens
- ED** = Per forni a cottura diretta / For direct cooking ovens
- BQ** = Per barbecues / For barbecues
- PH** = Per riscaldatori / For heaters



Dimensioni in millimetri (LxPxH) - Pesi in Kg.

Dimensions in millimeters (WxDxH) - Weight in Kg.

**IS Kit conversione forno da incasso a esterno / Set to convert a Built in oven into an outdoor oven**



Codice Code	Descrizione / Informazioni prodotto Description / Item's info	Serie forno Ovens series	Peso Weight
KEV50	Kit per forni, tetto Verniciato / Kit for ovens, roof painted	50	
KEV65	Kit per forni, tetto Verniciato / Kit for ovens, roof painted	65	
KEV65X	Kit per forni, tetto Acciaio Inox / Kit for ovens, roof in stainless steel	65	
KEV80	Kit per forni, tetto Verniciato / Kit for ovens, roof painted	80	
KEV80X	Kit per forni, tetto Acciaio Inox / Kit for ovens, roof in stainless steel	80	
KEV100	Kit per forni, tetto Verniciato / Kit for ovens, roof painted	100	
KEV100X	Kit per forni, tetto Acciaio Inox / Kit for ovens, roof in stainless steel	100	
KEVWX	Kit per forni, tetto Acciaio Inox / Kit for ovens, roof in stainless steel	Sedicinoni	

**ES Carrelli per forni a combustione separata / Carts for separated combustion ovens**



Codice Code	Descrizione / Informazioni prodotto Description / Item's info	Serie forno Ovens series	Dimensioni dimensions	Peso Weight
C50	Verniciato / Painted	50	615x650x715	30
C65	Verniciato / Painted	65	755x775x650	42
C65X	Inox / Stainless steel	65	755x775x650	42
C80	Verniciato / Painted	80	805x930x650	50
C80X	Inox / Stainless steel	80	805x930x650	50
CW	Verniciato nero / Black painted	Sedicinoni	1005x780x640	53
CWA	Verniciato Marrone, vano aperto / Brown painted, without door	Sedicinoni Country	1005x780x640	53
C100	Verniciato / Painted	100	805x1120x650	53
C100X	Inox / Stainless steel	100	805x1120x650	53

**ED Carrelli per forni a cottura diretta / Carts for direct cooking ovens**



Codice Code	info prodotto Item's info	Forno Oven	Dimensioni dimensions	Peso Weight
CPTV	Verniciato Nero / Black painted	Più trecento	990x1085x905	38,5
CFNV	Verniciato Nero /Black painted	Nonna Luisa/Benni	990x785x905	28
CFNX	Inox / Stainless steel	Nonna Luisa/Benni	990x785x905	28
CFCV	Verniciato Nero / Black painted	Campagnolo	790x690x850	19.5
CFCX	Inox / Stainless steel	Campagnolo	790x690x850	19.5

Dimensioni in millimetri (LxPxH) - Pesi in Kg.

Dimensions in millimeters (WxDxH) - Weight in Kg.

**ED Carrelli e supporti multiuso / Multipurpose carts and stands**



Codice Code	info prodotto Item's info	Dimensioni dimensions	Peso Weight
CMUM	Carrello cucina multiuso modulare Multi-purpose modular kitchen cart	705x775x900	28
CMUME	Prolunga per carrello cucina multiuso modulare Extention for multi-purpose modular kitchen cart	705x775x900	33
CCOV	VIA VAI Contenitore attrezzato x trasporto forno Mino completo di 1 Pala-teglia multiuso, 1 Palino tondo, 1 spazzola, 1 paletta ceneri VIA VAI Equipped container for oven MINO transport complete with 1 Multipurpose plate, 1 small round pizza shovel, 1 brush for ashes, 1 ash shovel	750x570x550	25

**IS Supporti per forni a combustione separata / Special stands for separated combustion ovens**



Codice Code	Serie forno Ovens series	Dimensioni dimensions	Peso Weight
S50	50	630x650x715	15
S65	65	770x775x650	14
S80	80	820x930x650	50
SW	Sedicinoni	1020x780x640	53
S100	100	820x1120x650	53

**ES FALO' Barbecue a legna e carbonella per forni  
Wood fueled and charcoal barbecue for separated combustion ovens**

Si applica a del forno, si utilizza lavorando frontalmente anzichè lateralmente;  
Alimentato a legna é un accessorio che trasforma il forno in una stazione di cottura completa.

Can be fixed to one or the other side of your outdoor oven to transform it in a complete cooking station.  
Fueled by wood, you can operate frontally instead of laterally.



Codice Code	Descrizione / Informazioni prodotto Description / Item's info	Serie forno Ovens series	Dimensioni dimensions	Dimensioni griglia Grid's dimensions	Peso Weight
BEF	Barbecue (tetto verniciato) (painted roof)	65/80/100	740x930x950	640x400	70
BTX	Supplemento per tetto Inox Surcharge for roof made in Stainless steel				
GB65X	Supplemento per griglia Inox / Surcharge for grid made in Stainless steel				

**ES IS CASSETTO BBQ per forni / Drawer BBQ for ovens**

Applicabile sui forni a combustione separata per esterno da 80; estraibile, si monta nella camera di combustione  
Installable on separated outdoor combustion ovens type "80"; it is extractable, it is mounted inside the combustion chamber



Codice Code	Descrizione / Informazioni prodotto Description / Item's info	Serie forno Ovens series	Dimensioni dimensions	Dimensioni griglia Grid's dimensions	Peso Weight
BCF	Barbecue estraibile / Extractable barbecue	80		480x390	

Dimensioni in millimetri (LxPxH) - Pesì in Kg.

Dimensions in millimeters (WxDxH) - Weight in Kg.

**IS HOT HOUSE kit riscaldamento ambienti per forni / Environment heating kit**

Hot House è un Kit di allestimento per il forno da incasso, 65 o 80. Con questo kit si può anche riscaldare l'ambiente.

Recuperando l'energia termica in esubero, tramite questo sistema di ventilazione l'aria viene soffiata attraverso un particolare labirinto (esclusiva Rossofuoco) permettendo di riscaldare ambienti fino a 80m<sup>2</sup>; Il potenziometro in dotazione consente di regolare la quantità d'aria in uscita.

Attenzione: ordinabile solo contestualmente al forno; non può essere applicato successivamente

This kit, made for 65 or 80 builtin ovens, transforms them in a heating system.

With this kit the produced heat is recuperated and through a special labyrinth (a distinctive feature of Rossofuoco's ovens) is blown through the outlets; so you can heat rooms up to 80 m<sup>2</sup>. With the outcome regulator you can control the flow of the air.

Attention, to be ordered only at the same time as the oven; it cannot be applied later

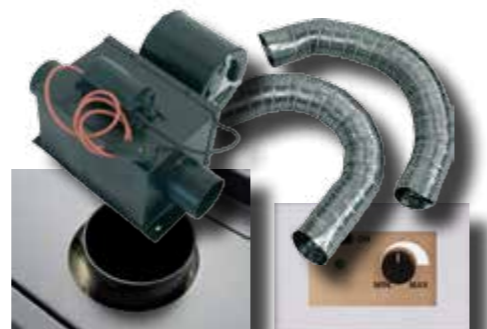

Codice Code	Descrizione / Informazioni prodotto	Description / Item's info	Serie forno Ovens series
RA 65	kit composto da trasformatore, motore, regolatore di velocità, 3 mt. di tubo flessibile, 2 bocchette in alluminio.	It's a kit consisting of transformer, power engine, outcome regulator, 9,84 ft. of flexible hoses, 2 outlets in aluminium.	65
RA 80			80

**ES Piano di lavoro laterale per forni a comb. separata / Lateral work top for separated comb. ovens**

Utilissimo pratico e robusto, ideale per appoggiarvi le teglie prima o dopo la cottura e per avere tutto a portata di mano.

It's a very practical lateral worktop for baking pans, tools...



Codice Code	Serie forno Ovens series	Dimensioni Dimensions	Peso Weight
PA50	50	640x300x30	
PA65	65	766x300x30	
PA80/100	80/100	920x300x30	
PAW	Sedicinoni	770x300x30	

**ES IS Mensola frontale per forni a Comb.separata / Front shelf for separated comb. ovens**

In acciaio Lucido

Made of Inox stainless steel



Codice Code	Serie forno Ovens series	Dimensioni Dimensions	Peso Weight
PAFR	65/80/100	520x90	

**ES Piano di lavoro frontale per "Sedicinoni" / Front work top for "Sedicinoni"**

Si appoggia sui manici estraibili del carrello

to place on the extrattable handles of the cart



Codice Code	Serie forno Ovens series	Dimensioni Dimensions	Peso Weight
PFW	Sedicinoni	1000x350x30	

**ED Piano laterale per forni a combustione diretta / Lateral worktop for Direct combustion ovens**

In acciaio Lucido Inox

Made of Inox stainless steel



Codice Code	Serie forno Ovens series	Dimensioni Dimensions	Peso Weight
PAFC	Campagnolo	670x350x30	
PAFN	Nonna Luisa/Benni	770x350x30	
PAFP	Piùtrecento	1070x350x30	

Dimensioni in millimetri (LxPxH) - Pesì in Kg.

Dimensions in millimeters (WxDxH) - Weight in Kg.

**ES IS Piana refrattaria supplementare / Additional refractory plate**

Si può anche posare sopra la griglia centrale per cuocervi pane o pizza. It can also be placed on the central grill to bake pizza or bread directly on it.



Codice Code	Serie forno Ovens series	Dimensioni dimensions	Peso Weight
PB50	50	340x480x15	
PB65	65	400x590x15	
PB80	80	400x745x15	
PB100	100	400x930x15	
PBWSC	Sedicinoni	660x600x15	
PBW	Sedicinoni ST (*)	660x400x15	

(\*) Forno non più in produzione / oven out of production

**ES IS Kit porchetta (griglia + teglia raccogligrassi) / Kit for big roasts (grill + fat collection pan)**

Per cuocere le carni, in modo dietetico con l'espulsione dei grassi che cadranno nell'ampia teglia posta nel piano basso con all'interno un pò d'acqua. Ideale per cuocere la classica "Porchetta". It's ideal for big roasts, so the fat drops into the wide pan placed underneath and containing a little bit of water.



Codice Code	Serie forno Ovens series	Dimensioni griglia Grill's dimensions	Peso Weight
GP65KIT	65	460x550x15	
GP80KIT	80	460x700x15	
GP100KIT	100	460x900x15	
GPWKIT	Sedicinoni	400x550x15	

**ES IS Griglia per porchetta / Special grill for big roasts**

Per cuocere grosse pezzature di carne ottenendo una cottura più dietetica con l'espulsione dei grassi. ATTENZIONE: per la raccolta dei grassi usare una sottostante teglia di ampiezza adeguata con dentro un pò di acqua. To cook large pieces of meat obtaining a more dietetic cooking. ATTENTION: for the collection of dropping ats, use an underlying tray of adequate width with some water inside.

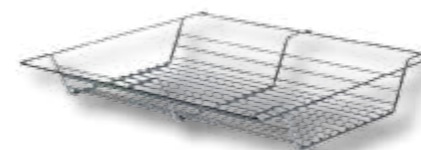

Codice Code	Serie forno Ovens series	Dimensioni dimensions	Peso Weight
GP65	65	460x550x15	
GP80	80	460x700x15	
GP100	100	460x900x15	
GPW	Sedicinoni	400x550x15	

**ES IS Griglia piana per forni a combustione separata / Plain grid for separated combustion ovens**



Codice Code	Serie forno Ovens series	Dimensioni dimensions	Peso Weight
GR50	50	390x480	
GR65	65	462x550	
GR80	80	462x700	
GR100	100	462x900	
GRWXL	Sedicinoni	705x600	
GRWST	Sedicinoni ST (*)	700x462	

(\*) Forno non più in produzione / oven out of production

**BQ Griglie per barbecue / Additional standard grids for barbecues**

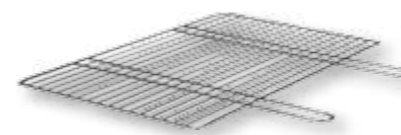

Codice Code	Barbecue	Barbecue	Dimensioni dimensions
GB50	Cassetto BBQ	Cromata/Chrome	390x480
GB65	Falò/EasyUP	Cromata/Chrome	640x400
GB65X	Falò/EasyUP	Inox/stainless steel	640x400
GB80	Maxi	Cromata/Chrome	790x400
GB80X	Maxi	Inox/stainless steel	790x400

Dimensioni in millimetri (LxPxH) - Pesi in Kg.

Dimensions in millimeters (WxDxH) - Weight in Kg.

**ES IS Teglie / Baking pans**

Fatte in alluminio sono disponibili in varie forme e dimensioni.

Made of aluminium, in various shapes and sizes.



Codice Code	Descrizione / Info prodotto Description / Item's info	Dimensioni Dimensions
TL35	Rotonda / Round	Diam. 350x30
TLQ	Quadrata / Square	400x400x30
TL50	Rettangolare / Rectangular	330x450x30
TL65	Rettangolare / Rectangular	400x580x30x
TL80	Rettangolare / Rectangular	400x680x30
TL100	Rettangolare / Rectangular	400x880x30
TLW	per / for Sedicinoni	400x650x30
TLWS (*)	per / for Sedicinoni	2pz: 330x620x30

(\*) Set di 2 pezzi che permette di occupare tutto il piano del forno  
Set of 2 pieces that allows to occupy the whole surface of the grid

**ES IS Teglie a bordo alto / High edge baking pans**

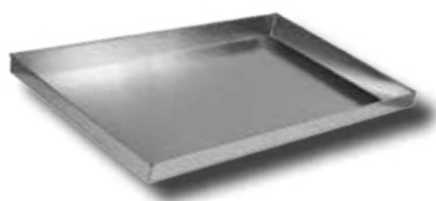

Codice Code	Serie forno Ovens series	Dimensioni Dimensions
TLA65	65	400x530x50
TLA80	80	400x680x50
TLA100	100	400x880x50

**ES IS Teglia a bordo alto con manici / High edge baking pan with handles**



Attenzione, verificare prima dell'acquisto la dimensione della camera di cottura del proprio forno.

Warning, before ordering please verify the size of the cooking chamber of your oven.

Codice Code	Serie forno Ovens series	Dimensioni Dimensions	Peso Weight
TLAM		370x620x60	

**ES IS Teglia bluita per pizza / Blue steel baking pan for pizza**



Codice Code	Serie forno Ovens series	Dimensioni Dimensions	Peso Weight
TLB	65/80/100	600x400x20	

**ES IS Teglia forata per pane / Perforated baking pans for bread**



Codice Code	Tipo Type	Dimensioni Dimensions
TLF37	Quadrata / Square	370x370x30
TLF72	Rettangolare / Rectangular	370x720x30

Dimensioni in millimetri (LxPxH) - Pesi in Kg.

Dimensions in millimeters (WxDxH) - Weight in Kg.

**ES IS ED Pale pane pizza / Bread and pizza shovels**

Indispensabili per infornare pane o pizza da cuocere direttamente sulla piastra refrattaria; realizzata in acciaio inox con manico cromato e terminale in legno.

Indispensable to place pizza or bread directly on the refractory plate; are made of stainless steel with chrome handle and wooden grip.

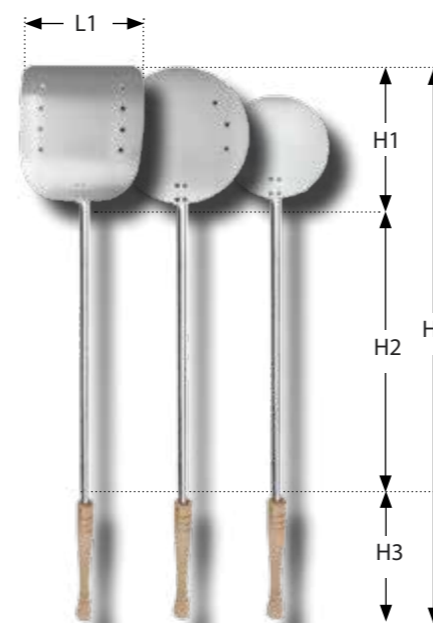

Standard / Standard

Codice Code	Descrizione / Info prodotto Description / Item's info	Dimensioni/Dimensions				
		L1	H1	H2	H3	H4
PLQ	Pala quadrata / Squared shovel	290	330	770	260	1360
PLR	Pala tonda / Round shovel	280	280	770	260	1310
PLRS	Palino tondo / Small round shovel	200	200	770	260	1230

Per carrello modulare multiuso (CMUM) / For multi-purpose modular cart (CMUM)

Codice Code	Descrizione / Info prodotto Description / Item's info	Dimensioni/Dimensions				
		L1	H1	H2	H3	H4
PLQC	Pala quadrata / Squared shovel	290	330	565	260	1115
PLRC	Pala tonda / Round shovel	280	280	565	260	1105
PLRSC	Palino tondo / Small round shovel	200	200	565	260	1045

**ED Accessori per la pulizia / Cleaning tools**

Pensati per i forni a combustione diretta

Designed for direct combustion ovens

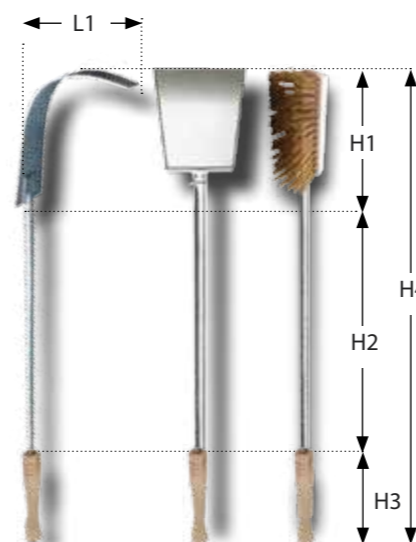

Accessori di pulizia standard / Standard cleaning tools

Codice Code	Descrizione / Info prodotto Description / Item's info	Dimensioni/Dimensions				
		L1	H1	H2	H3	H4
RBF	Raccogli-spargi brace / Embers collector	150	240	770	260	1270
PCB	Paletta per ceneri / Shovel for ashes	170	200	770	260	1230
SCB	Spazzola per ceneri / Brush for ashes	50	170	670	260	1200

Per carrello Cucina modulare multiuso (CMUM) / For multi-purpose modular kitchen cart (CMUM)

Codice Code	Descrizione / Info prodotto Description / Item's info	Dimensioni/Dimensions				
		L1	H1	H2	H3	H4
RBFC	Raccogli/spargi brace / Embers collector	150	240	565	260	1065
PCBC	Paletta per ceneri / Shovel for ashes	170	200	600	260	1060
SCBC	Spazzola per ceneri / Brush for ashes	50	170	520	260	1050

**ED Strumenti per VIAVAI / Tools for VIAVAI**



Codice Code	Descrizione / Info prodotto Description / Item's info
RBFV	Pala teglia multiuso / Multipurpose plate
PLRV	Palino tondo/ Small round shovel
SCBV	Spazzola per ceneri / Brush for ashes
PCBV	Paletta per ceneri / Ash shovel

Dimensioni in millimetri (LxPxH) - Pesì in Kg.

Dimensions in millimeters (WxDxH) - Weight in Kg.

**ES IS ED Portapale / Shovel holder**



Codice Code	Descrizione / Info prodotto Description / Item's info
PPL4E	Portapale 4 posti (vuoto) / Shovel holder, 4 slots (empty)
PPL6E	Portapale 6 posti (vuoto) / Shovel holder, 6 slots (empty)



**ES IS ED Kit strumenti "QUATTRO" / Tool kit "QUATTRO"**



Codice Code	Descrizione Info prodotto	Description Item's info
ACK04	Composto da: Pala rettangolare PLQ, Palino rotondo PLRS, Paletta ceneri PCB, Spazzola SCB	Made of: Squared shovel PLQ, Small round shovel PLRS, Shovel for ashes PCB, Brush for ashes SCB
ACK04C	<b>Per Carrello cucina CMUM</b> Composto da: Pala rettangolare PLQC, Palino rotondo PLRSC, Paletta ceneri PCBC, Spazzola SCBC	<b>for kitchen cart CMUM</b> Made of: Squared shovel PLQ, Small round shovel PLRS, Shovel for ashes PCB, Brush for ashes SCB

**ES IS ED Kit strumenti "SEI" / Tool kit "SEI"**



Codice Code	Descrizione Info prodotto	Description Item's info
ACK06	Composto da: Pala rettangolare PLQ, pala rotonda PLR, palino rotondo PLRS, spargibraci RBF, paletta ceneri PCB, spazzola SCB	Made of: Squared shovel PLQ, round shovel PLR, small round shovel PLRS, embers collector RBF, shovel for ashes PCB, brush for ashes SCB

**ED Controcappa frontale / Front counter hood**

La "controcappa" frontale è progettata per il contenimento di fumi e vapori in caso di installazione del forno a cottura diretta in ambienti chiusi. Disponibile solo per i modelli "Più trecento" e "Nonna Luisa".

The front "counter-hood" is designed for the containment of smokes and steams in case of installation in closed environments. Available only for "Più trecento" and "Nonna Luisa".

**Attenzione:** ordinabile solo contestualmente al forno; non può essere applicata successivamente.

**Attention:** to be ordered only at the same time as the oven; it cannot be applied later.



Codice Code	Descrizione / Info prodotto Description / Item's info	per For	Dimensioni Dimensions
CCFD	Controcappa /Counter hood	Nonna Luisa	
CCFD	Controcappa /Counter hood	Più trecento	

Dimensioni in millimetri (LxPxH) - Pesì in Kg.

Dimensions in millimeters (WxDxH) - Weight in Kg.

**ES ED BQ Cappottine impermeabili / Waterproof covers**



Codice Code	Descrizione / Info prodotto Description / Item's info
<b>Per forni a combustione separata / For separated combustion ovens</b>	
CPFS80	per forno da 80 / for ovens type 80
CPFS100	per forno da 100 / for ovens type 100
CPFSSN	per forno "Sedicinoni" / for oven "Sedicinoni"
<b>Per forni a combustione diretta / For direct combustion ovens</b>	
CPFDNL	per forni "Nonna Luisa" e Benni / for oven "Nonna Luisa" and "Benni"
CPFDPT	per forno "Più trecento" / for oven "Più trecento"
<b>Per barbecue Stand alone / For stand alone barbecue</b>	
CPBBEU	per barbecue "Easy Up" / for "Easy Up" barbecue
CPBBMX	per barbecue "Maxi" / for "Maxi" barbecue
<b>Per Riscaldatori pirolitici / For outdoor patio heaters</b>	
CPRPRB	per riscaldatore "Rubino" / for "Rubino" heater
CPRPDM	per riscaldatore "Diamante" / for "Diamante" heater

**ES IS BQ Accenditore per carbonella / Charcoal fire starter**



Un accessorio utilissimo che consente di accendere rapidamente la carbonella per il barbecue; sarà sufficiente inserire la carbonella nella parte superiore accendendo poi sotto il nostro strumento un comunissimo cubetto "accendi fuoco".

A very useful tool that allows to fire and to get quickly ready the charcoal for the barbecue; just putting some coal in the upper part and lighting a firestarter block/stick in the lower part.

Codice Code	per For	Info prodotto Item's info
ACF	Barbecue forni / Oven's Barbecue	Verniciato / Painted
ACB	Easy Up	Verniciato / Painted

**BQ Piani per "Easy Up" e "Falò Solo" / Shelves for "Easy Up" and "Falò Solo"**



Codice Code	Info prodotto Item's info	per For	Dimensioni Dimensions
PBV	2 piani verniciati / 2 painted shelves	Easy Up	440X300

Dimensioni in millimetri (LxPxH) - Pesi in Kg.

Dimensions in millimeters (WxDxH) - Weight in Kg.

**ED Ricambi per bruciatori a gas / Spare parts for Gas burners**



**Bruciatore a gas / Gas burners**

Codice Code	per For	Info prodotto Item's info
FDGASB1E	Nonna Luisa, Più trecento	Certificazione Europea European Certification
FDGASB1U	Nonna Luisa, Più trecento	Certificazione Statunitense US Certification

**ATTENZIONE:** in fase di ordine comunicare il tipo di gas che viene utilizzato ed in che paese.

**WARNING:** when ordering, communicate the type of gas that is used and in which country

Dati tecnici del bruciatore a gas		Technical data of the gas burner	
Potenza termica	da 5,7 a 16kw a seconda del gas utilizzato	Thermal power	from 5,7 to 16kw depending on the type of gas
Consumo	da 0,6 a 2,7 kg/h a seconda del gas utilizzato	Consumption	da 0,6 a 2,7 kg/h depending on the type of gas
Peso / Weight	7,5 kg	Weight	7,5 kg
Tipo di allacciamento gas	1/2 BSP/G	type of gas connection	1/2 BSP/G
Rendimento combustione	80%	Combustion efficiency	80%



**Frangi fiamma per bruciatore a gas / Flame distributor for gas burner**

Codice Code	per For	Info prodotto Item's info
FDGASFF	Nonna Luisa, Più trecento	Inox / Stainless steel

**Mattone per forni con bruciatore a gas / Brick for ovens with gas burner**

Codice Code	per For	Info prodotto Item's info
FDGASMX	Nonna Luisa, Più trecento	Inox / Stainless steel

**PH Ricambi per riscaldatori / Spare parts for heaters**

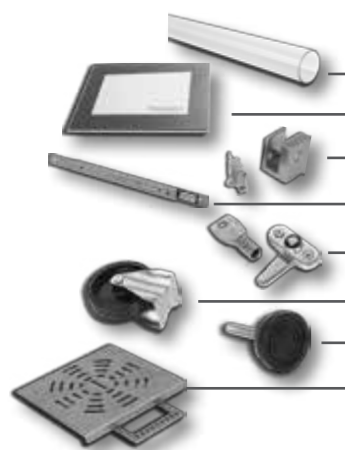

Codice Code	Per for	Descrizione / Info prodotto Description / Item's info
RIRPTVB	Rubino	Tubo vetro borosilicato / Borosilicate glass tube
RIRPVTS	Diamante	Vetro singolo serigrafato / Single screen-printed glass
RIRPSUV	Diamante	Supporto singolo per vetro / Single glass holder
RIRPGUB	Rubino/Diamante	Coppia guide inox bruciatore / Pair of guides for burner
RIRPCHB	Rubino/Diamante	Chiusura con chiave sportello / Lock with door key
RIRPRUS	Rubino/Diamante	Ruota singola per bruciatore / Single wheel for burner
RIRPPIS	Rubino/Diamante	pedino basamento bruciatore / Single base foot
RIRPFAB	Rubino/Diamante	Farfalla bruciatore / Extractable burner base

Dimensioni in millimetri (LxPxH) - Pesi in Kg.

Dimensions in millimeters (WxDxH) - Weight in Kg.

**BQ Braciere brucialegna per Falò/ Brazier for "Falò"**



Codice Code	Descrizione / Info prodotto Description / Item's info	Dimensioni Dimensions
RI BRF	Per barbecue "Falò" / for barbecue "Falò"	

**ED Braciere brucialegna / Brazier**



Codice Code	Descrizione / Info prodotto Description / Item's info	Dimensioni Dimensions
RI BRD	Per forni a cottura diretta a legna / for wood fueled cooking ovens	

**ED Mattone refrattario / Refractory brick**



Codice Code	Descrizione / Info prodotto Description / Item's info	Dimensioni Dimensions
FDLEGMR	Per forni a cottura diretta a legna / for wood fueled cooking ovens	200x300

**ED Kit braciere + refrattario / Kit Brazier + Refractory brick**



Consente la trasformazione del forno a cottura diretta, da versione a Gas a versione a Legna

Allows the transformation of a direct cooking oven, from Gas version to Wood version

Codice Code	Descrizione / Info prodotto Description / Item's info	Dimensioni Dimensions
FDGASKBM	Per forni a cottura diretta a legna / for wood fueled cooking ovens	

**ES ED BQ Comignoli / Chimneys**



Codice Code	Descrizione / Info prodotto Description / Item's info	per For	Dimensioni Dimensions
RICM060	Comignolo h 600	Forni a combustione separata Separated combustion ovens	h 600 - Ø 130
RICM100	Comignolo h 1000		h 1000 - Ø 130

Codice Code	Descrizione / Info prodotto Description / Item's info	per For	Dimensioni Dimensions
RICMCB	Corpo comignolo Chimney body	Barbecue "Falò"	Ø 130
RICMCD	Corpo comignolo Chimney body	Forni a cottura diretta (esclusi Benni e Mino) Direct cooking ovens (except Benni and Mino)	Ø 150
RICMCDB	Corpo comignolo con valvola Chimney body with valve	Forno BENNI \ Oven BENNI	Ø 130
RICMCDM	Corpo comignolo con valvola Chimney body with valve	Forno MINO \ Oven MINO	Ø 100

Codice Code	Descrizione / Info prodotto Description / Item's info	per For	Dimensioni dimensions
RICMCA	Cappello comignolo Chimney cap	Campagnolo / Nonnaluisa / Più trecento	Ø 150
RICMCAB	Cappello comignolo Chimney cap	Forno BENNI \ Oven BENNI	Ø 130
RICMCAM	Cappello comignolo Chimney cap	Forno MINO \ Oven MINO	Ø 100
RICMCV	Cappello comignolo Antivento Windproof chimney cap	Forni a combustione separata Separated combustion ovens	Ø 130

Dimensioni in millimetri (LxPxH) - Pesì in Kg.

Dimensions in millimeters (WxDxH) - Weight in Kg.

**ES** **IS** **Tetto interno per "Garden" / Internal roof for "Garden"**



Codice Code	Descrizione / Info prodotto Description / Item's info	Dimensioni Dimensions	
RITIG80	Per forno "Garden" da 80 / for oven "Garden" type 80		
RITIG100	Per forno "Garden" da 100 / for oven "Garden" type 100		

**ES** **IS** **Griglia fuoco per forni a comb. separata / Fire grill for separated comb. ovens**

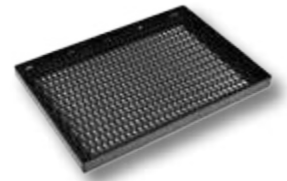

Codice Code	Descrizione / Info prodotto Description / Item's info	Dimensioni Dimensions	
RIGRF50	Per forni serie 50 / for series 50 ovens		
RIGRF65	Per forni serie 65 / for series 65 ovens		
RIGRF80	Per forni serie 80 / for series 80 ovens		
RIGRF100	Per forni serie 100 / for series 100 ovens		
RIGRFW	Per "Sedicinoni" / for "Sedicinoni"		

**ES** **IS** **Cassetto cenere per forni a comb. separata / Ash tray for separated comb. ovens**



Codice Code	Descrizione / Info prodotto Description / Item's info	Dimensioni Dimensions	
RICCF50	Per forni serie 50 / for series 50 ovens		
RICCF65	Per forni serie 65 / for series 65 ovens		
RICCF80	Per forni serie 80 / for series 80 ovens		
RICCF100	Per forni serie 100 / for series 100 ovens		
RICCFW	Per "Sedicinoni" / for "Sedicinoni"		

**ES** **IS** **Maniglie per forni a comb. separata / Handles for separated comb. ovens**



Codice Code	Descrizione / Info prodotto Description / Item's info	Dimensioni Dimensions	
RIMMO	Molla di finitura per maniglia standard Finishing spring for standard handle		
RIMLI	Maniglia "Line" Handle "Line"		
RIMW	Maniglia per "Sedicinoni" Handle for "Sedicinoni"		

**ES** **IS** **Coppia cerniere sportelli / Pair of hinges for doors**



Codice Code	per For	Dimensioni Dimensions	
RICEW	Sedicinoni		

Dimensioni in millimetri (LxPxH) - Pesì in Kg.

Dimensions in millimeters (WxDxH) - Weight in Kg.

**ES** **IS** **Pomelli per forni a comb. separata / Knobs for separated comb. ovens**



Codice Code	Descrizione / Info prodotto Description / Item's info	Dimensioni Dimensions	
RIPOV	Pomello valvole fumi o vapore Fume or steam valve knob		
RIPOA	Pomello controllo areazione Ventilation control knob		

**ES** **IS** **Kit ventilazione per forni ventilati / Ventilation kit for fan ovens**



Codice Code	Descrizione / Info prodotto Description / Item's info	Dimensioni Dimensions	
RIKVE	Motore e ventola per forni ventilati / Engine and fan for ventilated ovens		

**ES** **IS** **Trasformatore / AC adapter**



Codice Code	Descrizione / Info prodotto Description / Item's info	
RITRF	Trasformatore elettrico, da 220/230V a 12V, per alimentazione elettrica forni (escluso SEDICINONI) AC adapter, from 220 / 230V to 12V, for electric power supply of ovens (excluding SEDICINONI)	
RITRFS	Trasformatore elettrico da 220/230V a 12V per alimentazione elettrica forno SEDICINONI AC adapter from 220 / 230V to 12V for electric power supply of the SEDICINONI oven	

**ES** **IS** **Kit guarnizione sportello / Door gasket kit**

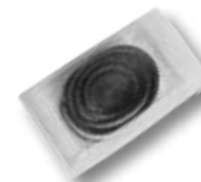

Codice Code	Descrizione / Info prodotto Description / Item's info	Dimensioni Dimensions	
RIGAC	Guarnizione di ricambio per sportello camera di combustione dei forni a combustione separata Spare gasket for combustion chamber door of separated combustion ovens		

**ES** **IS** **Illuminazione camera di cottura / Lighting of the cooking chamber**



Codice Code	Descrizione / Info prodotto Description / Item's info	Dimensioni Dimensions	
RIPLC	Portalamпада completo per sistema di illuminazione interno della camera di cottura dei forni a combustione separata Complete lamp holder for internal lighting system of the cooking chamber of separate combustion ovens		
RILAM	Lampadina di ricambio per sistema di illuminazione interno della camera di cottura dei forni a combustione separata Replacement bulb for internal lighting system of the cooking chamber of separate combustion ovens		

Dimensioni in millimetri (LxPxH) - Pesì in Kg.

Dimensions in millimeters (WxDxH) - Weight in Kg.

**ES IS Interruttori / Switches**

Codice Code	Descrizione / Info prodotto Description / Item's info	Dimensioni Dimensions
RIINM	Coppia interruttori in struttura metallica Pair of switches in metal structure	
RIINP	Coppia interruttori in struttura di plastica Pair of switches in plastic structure	

**ES IS ED Termometri / Thermometers**

Codice Code	Descrizione / Info prodotto Description / Item's info	Dimensioni Dimensions
RITMB1	Termometro a bulbo per forni serie 50 Bulb thermometer for 50 series ovens	
RITMB2	Termometro a bulbo esclusi forni serie 50 Bulb thermometer for all ovens except 50 series	
RITMST	Termometro a staffa per forni a cottura diretta Bracket thermometer for direct cooking ovens	
RITMIR	Termometro laser digitale ad infrarossi per MINO Infrared digital laser thermometer for MINO	

**ES IS Timer / Timer**

Codice Code	Descrizione / Info prodotto Description / Item's info	Dimensioni Dimensions
RITRM	Contaminuti Timer	

**ES ED Ruote / Wheels**

Codice Code	Descrizione / Info prodotto Description / Item's info	Dimensioni Dimensions
RIRUC	Ruota singola per carrello forni a combustione separata Single wheel for carts of separate combustion ovens	
RIRUT	Ruota singola per carrelli forni a cottura diretta Single wheel for carts of direct cooking ovens	
RIRUTF	Ruota singola per carrelli forni a cottura diretta con freno Single wheel with brake for carts of direct cooking ovens	

Color palette  
**Gamma colori**

**Sedicioni**

Frontale Front	Fianchi Sides	Tetto Roof
Acciaio (Steel)	Nero (Black)	Acciaio (Steel)

**Steel**

Frontale Front	Fianchi Sides	Tetto Roof
Acciaio (Steel)	Nero (Black)	Acciaio (Steel)

**Rame**

Struttura Body
Nero (Black)

**Red**

Struttura Body
Rosso (red)

**Fiamma - Effe - Eco - Eco50**

Struttura Body	Tetto Roof
Grigio Lava (Lava grey)	Rosso (Red)

**Raggio**

Struttura Body	Tetto Roof
Marrone ossido (Oxide Brown)	Nero (Black)

**Garden Garden plus**

Struttura Body	Tetto Roof
Marrone (Brown)	Nero (Black)

**Garden color**

Frontale Front	Fianchi Sides	Tetto Roof
Grigio Lava (Lava grey)	Marrone (Brown)	Grigio (Grey)
	Rosso (Red)	Rosso (Red)
	Grigio Lava (Lava Grey)	Grigio (Grey)
	Marrone (Brown)	Grigio Lava (Lava Grey)
	Panna (Cream)	Marrone (Brown)
		Panna (Cream)
		Rosso (Red)
		Acciaio (Steel)

**Più trecento**

Carter Crankcase	Carrello Cart
Rosso (Red)	Nero (Black)

**Campagnolo, Nonna Luisa**

Carter Crankcase	Carrello Cart
Rosso (Red)	Marrone (Brown)
	Nero (Black)
	Acciaio (Steel)

**Benni**

Carter Crankcase	Carrello Cart
Marrone ossido (Oxide Brown)	Nero (Black)
	Acciaio (Steel)

**Mino**

Carter Crankcase
Arancione (Orange)

Le colorazioni sono riportate a titolo esemplificativo e non esaustivo. Per ragioni tecniche di stampa e/o per variazioni intervenute nella produzione di materie e materiali e/o per il lotto di appartenenza dei medesimi, i colori riportati nel presente catalogo, possono differire dagli originali.

The colors are given as an example and not limited to. For technical reasons of printing and / or for variations in the production of the materials and / or for the batch to which they belong, the colors shown in this catalog may differ from the originals.

## Note, termini e condizioni commerciali

### Colori, modelli, finiture e caratteristiche tecniche

Quanto riportato nel presente catalogo ha valore esclusivamente illustrativo e non costituisce offerta al pubblico. L'azienda si riserva il diritto di apportare modifiche, anche senza preavviso ai prodotti qui illustrati.

Le colorazioni sono riportate a titolo esemplificativo e non esaustivo in quanto, per ragioni tecniche di stampa e/o per variazioni intervenute nella produzione di materie e materiali e/o per il lotto di appartenenza dei medesimi, i colori riportati nel presente catalogo, possono differire dagli originali.

### Prezzi

Franco nostro stabilimento e con imballo al costo.

### Ordini

Tutti gli ordini sono subordinati all'accettazione da parte del produttore.

### Termini di consegna

La data di consegna anche se confermata è comunque indicativa, eventuali ritardi non daranno diritto ad annullamento dell'ordine o risarcimento.

### Resa in Italia

Franco nostro stabilimento.

### Contestazioni

La merce viaggia sempre a rischio e pericolo del committente anche se inviata franco destino; controllare la merce all'atto del ritiro e contestare immediatamente al vettore mancanze o avarie, con riserva scritta sul documento di trasporto; in mancanza di ciò la consegna si intende accettata senza alcuna riserva.

Eventuali altri reclami, non imputabili a quanto sopra dovranno pervenirci per iscritto entro 8 (otto) giorni dal ricevimento delle merci.

Non si accettano ritorni di merce se non espressamente autorizzati per iscritto dal produttore.

### Pagamenti

Sono riconosciuti validi solo i pagamenti effettuati direttamente al produttore o tramite istituti bancari.

Nel caso di ritardato pagamento decorreranno gli interessi di mora al tasso bancario in vigore e l'evasione di eventuali ordini in corso o successivi verrà sospesa.

Si precisa che le vendite si intendono eseguite in condizioni di "sospensiva", per cui la merce rimane di proprietà del produttore sino al totale pagamento.

In mancanza di pagamento a saldo gli eventuali acconti già effettuati resteranno acquisiti dal produttore a titolo di rimborso spese, danni e deprezzamento merce.

### Modifiche

Il produttore si riserva il diritto di modificare le caratteristiche costruttive e le dimensioni in ogni momento senza alcun preavviso.

### Foro competente

Per qualsiasi controversia il Foro competente sarà quello nell'ambito del quale ha sede il produttore.

## Note, commercial terms and conditions

### Colors, models, finishes and technical characteristics

The contents of this catalog are for illustrative purposes only and do not constitute an offer to the public. The company reserves the right to make changes, even without notice, to the products shown here.

The colors are given by way of example and not limited to the fact that, for technical printing reasons and / or for changes in the production of materials and / or for the batch they belong to, the colors shown in this catalog may differ from the originals.

### Prices

Ex-works from our factory and packaged at cost

### Orders

All orders are subject to acceptance by the manufacturer.

### Terms of delivery

The delivery date, even if confirmed, is still indicative, any delays will not give the right to cancel the order or compensation.

### Deliveries in Italy

Ex our factory.

### Disputes

The goods always travel at the customer's risk even if sent carriage paid; check the goods upon collection and immediately notify the carrier of shortcomings or failures, with a written reservation on the transport document; in the absence of this, delivery is considered accepted without reservation.

Any other complaints, not attributable to the above, must reach us in writing within 8 (eight) days of receipt of the goods.

Returns of goods are not accepted unless expressly authorized in writing by the manufacturer.

### Payments

Only payments made directly to the manufacturer or through banking institutions are recognized as valid.

In case of late payment, interest on arrears will start at the current bank rate and the processing of any orders in progress or later will be suspended.

It should be noted that sales are considered to be carried out under "suspension" conditions, whereby the goods remain the property of the producer until full payment.

In the absence of full payment, any advance payments already made will remain acquired by the manufacturer by way of reimbursement of expenses, damage and depreciation of the goods.

### Changes

The manufacturer reserves the right to modify the construction characteristics and dimensions at any time without notice.

### Jurisdiction

For any dispute, the competent court will be the one in which the manufacturer is based.

*Gentile rivenditore, nel ringraziarla per l'interesse accordatoci, siamo a ricordarle le varie modalità possibili per ricevere ulteriori informazioni e supporto alla vendita, nonché per l'inoltro degli ordini:*

Il suo agente di zona è:

\_\_\_\_\_

contattabile ai seguenti recapiti:

Tel.: \_\_\_\_\_ Cellulare: \_\_\_\_\_

Fax: \_\_\_\_\_ e-mail: \_\_\_\_\_

*Potra' quindi inoltrare direttamente gli ordini al suo agente utilizzando uno dei recapiti sopra indicati.*

### RIVENDITORE AUTORIZZATO

© Rossofuoco srl unipersonale 2022.- Opera protetta da copyright. - Catalogo 2022.1 - Tutte le immagini e/o i testi presenti in questo catalogo sono coperte dal diritto d'autore; ne è quindi vietato l'utilizzo anche parziale senza autorizzazione scritta dell'autore.  
Grafica by grafide@btpoint.eu +393355936050

© Rossofuoco srl 2022 - Work protected by copyright. - Catalog 2022.1 - All pictures and/or texts of this catalog are protected by copyright; any use, even partial, is forbidden without authorization. - Graphic by grafide@btpoint.eu +393355936050





[WWW.ROSSOFUOCO.COM](http://www.rossofuoco.com)



**Pagina Facebook :**

*acquisisci il QRcode a fianco  
con il tuo smartphone o tablet, o cerca:  
"RossoFuoco Forni" in Facebook.*



**Canale Youtube :**

*acquisisci il QRcode a fianco  
con il tuo smartphone o tablet, o cerca:  
"RossoFuoco Pizza" in youtube.*



**Instagram :**

*acquisisci il QRcode a fianco  
con il tuo smartphone o tablet, o cerca:  
"rossofuoco\_fornibarbecues" su Instagram.*



Realizzati e distribuiti da / Made and distributed by  
Rossofuoco s.r.l. unipersonale

Via Cavalieri di Vittorio Veneto, 21 - 61045 PERGOLA (PU) - ITALY

tel +39 0721 735926 - fax +39 0721 737107

mail: [info@rossofuoco.com](mailto:info@rossofuoco.com)