



ardesia®

RADIATORI TUBOLARI



La Cordivari vanta una consolidata tradizione industriale ed è una delle più importanti realtà italiane nel settore dell'idrotermosanitaria. Fondata nel 1972 dal Cav. Ercole Cordivari, l'azienda si specializza nella produzione di Bollitori, Recipienti in pressione, Serbatoi, Sistemi Termici Integrati, Radiatori d'Arredo, Sistemi per il Recupero e il Trattamento delle Acque, Sistemi Fumari e Contenitori per Alimenti.

I quattro poli produttivi Cordivari contano una superficie di oltre 370.000 metri quadri e impiegano più di 600 dipendenti. Tutti i manufatti sono progettati e prodotti in Italia negli stabilimenti Cordivari a garanzia della qualità totale e del Made in Italy. Grazie alle strategie di sviluppo orientate all'innovazione tecnologica e alla continua formazione del personale, la Cordivari risulta dotata di impianti moderni e processi produttivi all'avanguardia.

Le scelte tecnologiche, ergonomiche ed ecologiche consentono di operare nel pieno rispetto dell'uomo e dell'ambiente, secondo il Sistema di Gestione Ambientale UNI EN ISO 14001 e il regime di Qualità UNI EN ISO 9001 che garantisce la piena qualità e affidabilità dei suoi prodotti. Un management altamente qualificato, la continua ricerca di soluzioni innovative e un indirizzo fortemente orientato al cliente consentono oggi alla Cordivari una posizione di leadership di mercato e un know-how esclusivo nella produzione di Sistemi Integrati per il clima e comfort domestico. La testimonianza di un impegno continuo, teso al raggiungimento della Customer Satisfaction.

Cordivari company has a proven industrial tradition and is now one of the most important manufacturers in the heating and plumbing industry in Italy.

Founded in 1972 by Ercole Cordivari, the company is producing calorifiers & buffer tanks, solar thermal systems, compressed air receivers, design radiators, chimney flues and food containers. Cordivari plants are situated on an area of 370.000 square meters and employs more than 600 employees.

Thanks to its development strategies, all to new technologies and to the training of new human focused resources, Cordivari is equipped with modern structures and advanced production processes. All the products are designed and produced in Italy and the technological, ergonomic and ecological choices allow to work respecting the humans and its environment. UNI EN ISO 14001 environment managing systems and UNI EN ISO 9001 Quality system are perfectly integrated to grant and ensure company's main goals and values.

The highly qualified management, the constant research for innovative solutions and the extremely customer-oriented company policy, stands for the leading market position and the exclusive know-how in the field of integrated heating systems, that the Cordivari group has acquired. All this is the result of a continuous commitment to achieve Customer Satisfaction.



Cav. Ercole Cordivari

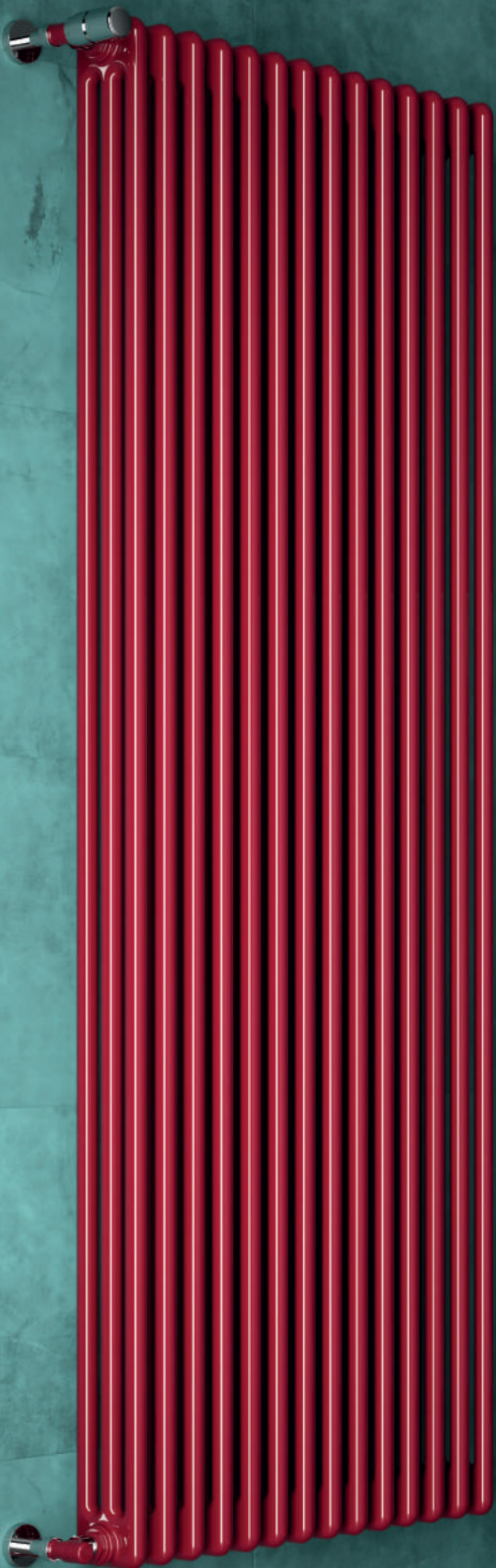

 **ardesia**[®]



SALDATURA TRA ELEMENTI ROBOTIZZATA CON PROCESSO DI PULSED SPRAY WELDING
ROBOTIZED WELDING BETWEEN SECTIONS THANKS TO PULSED SPRAY WELDING PROCESS

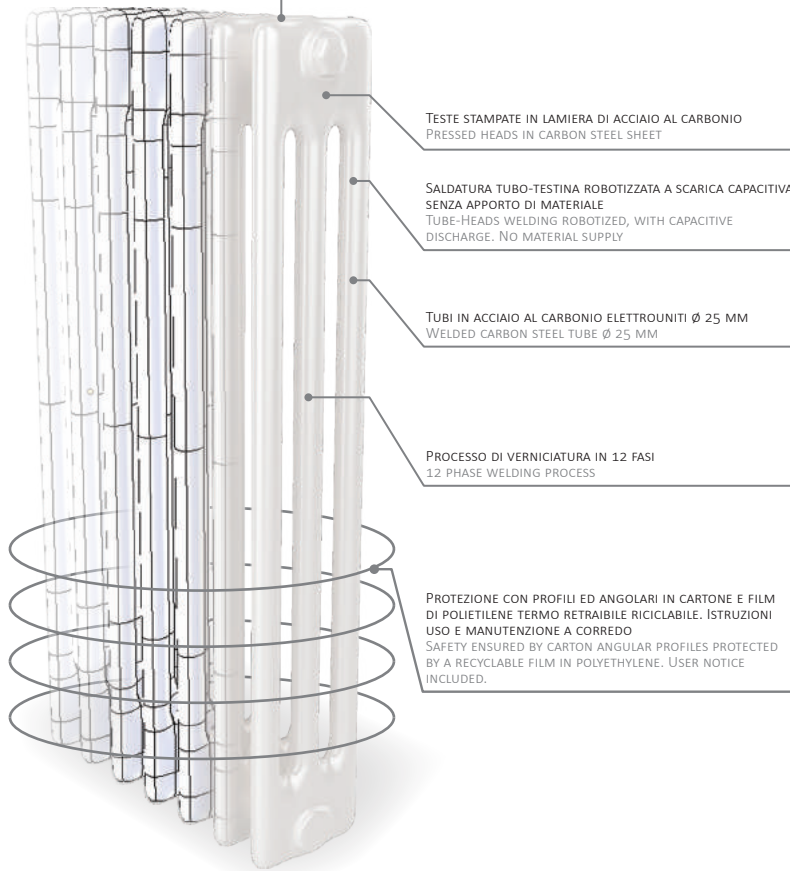

FUNZIONAMENTO FUNCTIONING

Acqua calda
Hot water

TEMPERATURA (max) TEMPERATURE (max)	Mozzo Hub	Passo Section width
110 °C	1"	46 mm

PRESSIONE P_{MAX}

10 bar	Condizione massima di esercizio Max Working Pressure	
13 bar	Condizione di collaudo Testing conditions	



TECNOLOGIA PRODUTTIVA AVANZATA E CONTROLLO QUALITATIVO SUL 100% DELLA PRODUZIONE

PRODUCTIVE HIGH-TECHNOLOGY AND QUALITY CONTROL ON 100% OF PRODUCTION

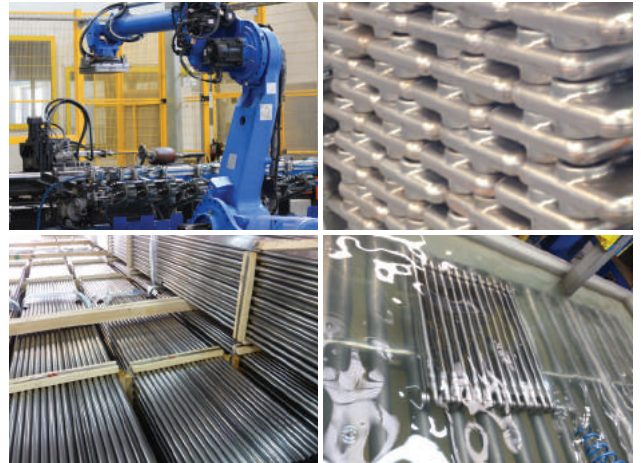

2 COLONNE
2 COLUMNS

3 COLONNE
3 COLUMNS

4 COLONNE
4 COLUMNS

5 COLONNE
5 COLUMNS

6 COLONNE
6 COLUMNS

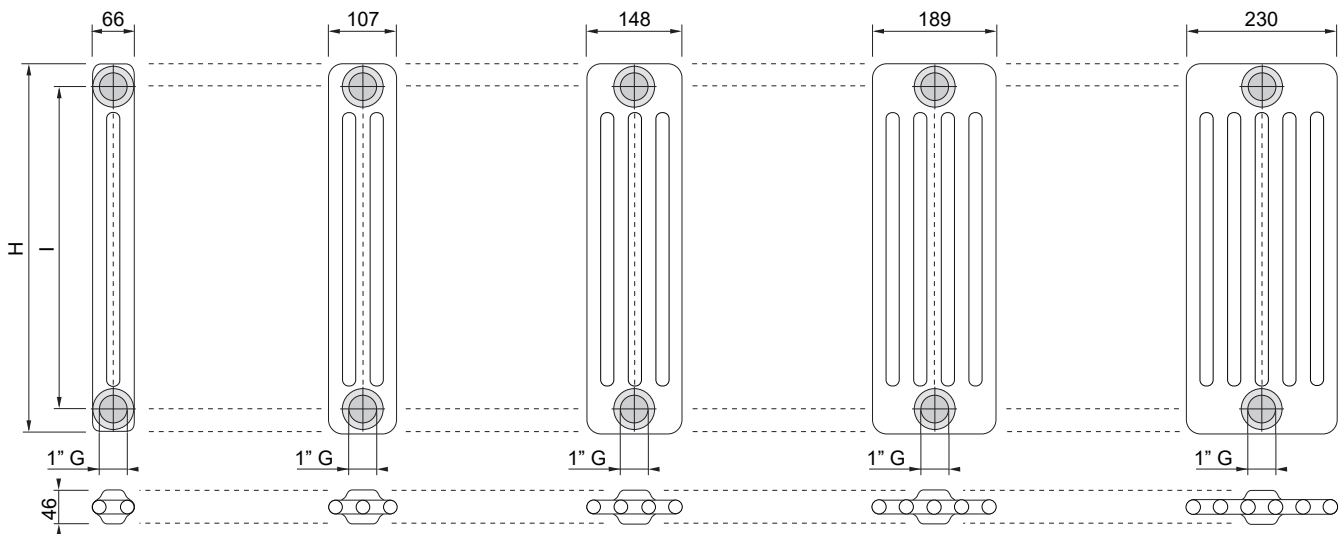

ALLACCIAMENTI LATERALE E CONTRAPPOSTO - SIDE AND OPPOSITE CONNECTIONS

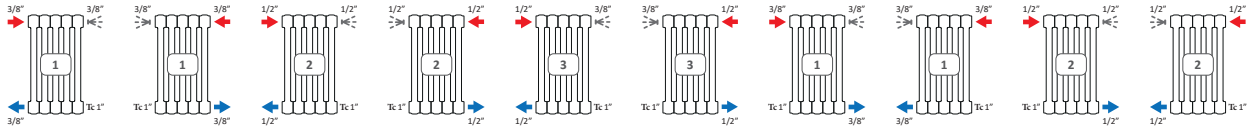

ALLACCIAMENTI DAL BASSO - BOTTOM-SIDE CONNECTIONS

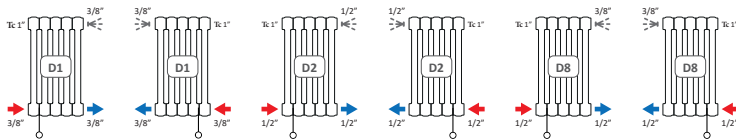

ALLACCIAMENTI UNIVERSALI UNIVERSAL CONNECTIONS

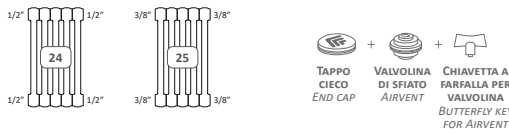

ALLACCIAMENTI PER NIPPLATURA CONNECTIONS FOR NIPPLING OPERATION



ALLACCIAMENTI MONOTUBO - BIDIRECTIONAL CONNECTIONS



ALLACCIAMENTI CONTRAPPOSTI SPECIALI OPPOSITE SPECIAL CONNECTIONS

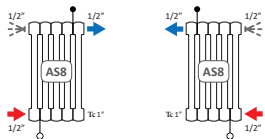

ALLACCIAMENTI CON MANICOTTI DALL'ALTO WITH UPPER SLEEVES CONNECTIONS

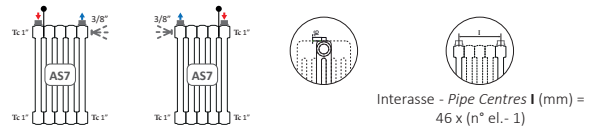

ALLACCIAMENTI CON MANICOTTI DAL BASSO UNDERNEATH WELDED SLEEVES CONNECTIONS

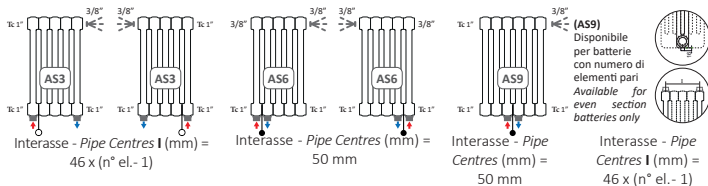

ALLACCIAMENTI COMPLETI CON MANICOTTI DAL BASSO INT.50 mm e VALVOLA TERMOSTATICA MONTATA* WELDED UNDERNEATH SLEEVES CONNECTIONS WITH PIPE CENTRES 50 MM 1/2" AND THERMOSTATIC HEAD MOUNTED*

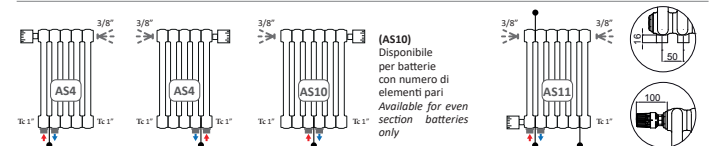

* Corpo Valvola e testa termostatica Oventrop con funzionamento liquido conforme alla UNI EN 215:2007
* Valve unit and Liquid thermostatic head Oventrop with liquid functioning in accordance with UNI EN 215:2007 regulation

	Entrata In		Uscita Out
	Sfiato Airvent		Manicotto Connection
	Diaphragma mobile Movable Diverter		Diaphragma saldato Welded Diverter
	Tappo cieco End Cap		Valvola termostatica Thermostatic head
	Monotubo Bidirectional		

COLONNE - COLUMNS					
Altezza (mm) Height (mm)	2	3	4	5	6
207					
At 60 = [W]	22,2	31,5	40,7	50,5	61,9
At 50 = [W]	17,5	24,8	32,0	39,7	48,7
At 40 = [W]	13,1	18,5	23,9	29,5	36,3
At 30 = [W]	9,0	12,7	16,3	20,1	24,8
Interasse [mm] Pipe Centres [mm]	151				
Contenuto [lt] Water Content [lt]	0,29	0,42	0,56	0,70	0,80
Peso a vuoto [kg] Dry Weight [kg]	0,35	0,53	0,71	0,89	1,07
Esponente [n] Exponent [n]	1,303	1,314	1,317	1,329	1,318

COLONNE - COLUMNS					
Altezza (mm) Height (mm)	2	3	4	5	6
300					
At 60 = [W]	32,1	43,7	58,9	71,9	86,1
At 50 = [W]	25,6	34,7	46,8	56,5	67,7
At 40 = [W]	19,4	26,1	35,3	42,1	50,4
At 30 = [W]	13,5	18,1	24,5	28,8	34,5
Interasse [mm] Pipe Centres [mm]	244				
Contenuto [lt] Water Content [lt]	0,37	0,54	0,72	0,90	1,10
Peso a vuoto [kg] Dry Weight [kg]	0,49	0,74	0,99	1,24	1,49
Esponente [n] Exponent [n]	1,247	1,273	1,265	1,320	1,322

COLONNE - COLUMNS					
Altezza (mm) Height (mm)	2	3	4	5	6
400					
At 60 = [W]	41,5	56,9	75,5	92,1	110,9
At 50 = [W]	33,0	45,1	59,8	72,4	87,3
At 40 = [W]	24,9	33,8	44,9	53,9	65,1
At 30 = [W]	17,3	23,4	31,1	36,8	44,6
Interasse [mm] Pipe Centres [mm]	344				
Contenuto [lt] Water Content [lt]	0,45	0,66	0,88	1,10	1,30
Peso a vuoto [kg] Dry Weight [kg]	0,63	0,95	1,27	1,59	1,92
Esponente [n] Exponent [n]	1,261	1,284	1,280	1,323	1,313

COLONNE - COLUMNS					
Altezza (mm) Height (mm)	2	3	4	5	6
500					
At 60 = [W]	50,6	69,9	91,7	111,7	134,7
At 50 = [W]	40,1	55,2	72,4	87,7	106,2
At 40 = [W]	30,2	41,4	54,2	65,3	79,3
At 30 = [W]	20,9	28,5	37,3	44,6	54,5
Interasse [mm] Pipe Centres [mm]	444				
Contenuto [lt] Water Content [lt]	0,53	0,79	1,04	1,30	1,60
Peso a vuoto [kg] Dry Weight [kg]	0,77	1,16	1,55	1,95	2,34
Esponente [n] Exponent [n]	1,275	1,296	1,296	1,326	1,305

COLONNE - COLUMNS					
Altezza (mm) Height (mm)	2	3	4	5	6
600					
At 60 = [W]	59,6	82,8	107,6	130,9	157,6
At 50 = [W]	47,1	65,2	84,7	102,7	124,5
At 40 = [W]	35,3	48,7	63,2	76,4	93,2
At 30 = [W]	24,4	33,5	43,4	52,1	64,2
Interasse [mm] Pipe Centres [mm]	544				
Contenuto [lt] Water Content [lt]	0,61	0,91	1,20	1,50	1,80
Peso a vuoto [kg] Dry Weight [kg]	0,91	1,37	1,84	2,30	2,76
Esponente [n] Exponent [n]	1,289	1,307	1,312	1,329	1,296

COLONNE - COLUMNS					
Altezza (mm) Height (mm)	2	3	4	5	6
750					
At 60 = [W]	73,2	101,9	131,3	159,2	190,7
At 50 = [W]	57,6	80,0	102,9	124,8	150,9
At 40 = [W]	43,0	59,6	76,4	92,7	113,3
At 30 = [W]	29,5	40,7	52,0	63,1	78,3
Interasse [mm] Pipe Centres [mm]	694				
Contenuto [lt] Water Content [lt]	0,73	1,09	1,44	1,80	2,20
Peso a vuoto [kg] Dry Weight [kg]	1,12	1,69	2,26	2,83	3,40
Esponente [n] Exponent [n]	1,310	1,325	1,335	1,334	1,284

COLONNE - COLUMNS					
Altezza (mm) Height (mm)	2	3	4	5	6
900					
At 60 = [W]	86,9	120,9	154,8	186,9	222,4
At 50 = [W]	68,1	94,6	120,8	146,4	176,4
At 40 = [W]	50,6	70,2	89,2	108,6	132,8
At 30 = [W]	34,5	47,7	60,4	73,9	92,1
Interasse [mm] Pipe Centres [mm]	844				
Contenuto [lt] Water Content [lt]	0,85	1,27	1,68	2,10	2,50
Peso a vuoto [kg] Dry Weight [kg]	1,33	2,01	2,68	3,36	4,03
Esponente [n] Exponent [n]	1,331	1,342	1,359	1,339	1,271

COLONNE - COLUMNS					
Altezza (mm) Height (mm)	2	3	4	5	6
1000					
At 60 = [W]	95,9	133,3	169,9	205,4	244,2
At 50 = [W]	75,2	104,3	132,7	160,6	192,9
At 40 = [W]	55,8	77,3	98,1	118,9	144,4
At 30 = [W]	38,0	52,5	66,4	80,7	99,5
Interasse [mm] Pipe Centres [mm]	944				
Contenuto [lt] Water Content [lt]	0,93	1,39	1,84	2,30	2,80
Peso a vuoto [kg] Dry Weight [kg]	1,48	2,22	2,96	3,71	4,46
Esponente [n] Exponent [n]	1,335	1,345	1,355	1,348	1,296

COLONNE - COLUMNS					
Altezza (mm) Height (mm)	2	3	4	5	6
1200					
At 60 = [W]	114,3	157,9	199,7	242,1	287,1
At 50 = [W]	89,5	123,5	156,2	188,8	224,7
At 40 = [W]	66,3	91,3	115,6	139,2	166,5
At 30 = [W]	45,1	61,9	78,5	93,9	113,1
Interasse [mm] Pipe Centres [mm]	1144				
Contenuto [lt] Water Content [lt]	1,09	1,63	2,17	2,70	3,20
Peso a vuoto [kg] Dry Weight [kg]	1,76	2,64	3,53	4,41	5,30
Esponente [n] Exponent [n]	1,343	1,350	1,348	1,366	1,345

COLONNE - COLUMNS					
Altezza (mm) Height (mm)	2	3	4	5	6
1500					
At 60 = [W]	142,6	194,6	244,3	297,0	349,7
At 50 = [W]	111,4	151,9	191,4	230,4	270,0
At 40 = [W]	82,3	112,2	142,0	168,8	196,8
At 30 = [W]	55,8	75,9	96,6	113,1	130,8
Interasse [mm] Pipe Centres [mm]	1444				
Contenuto [lt] Water Content [lt]	1,33	1,99	2,65	3,30	4,0
Peso a vuoto [kg] Dry Weight [kg]	2,18	3,28	4,37	5,47	6,57
Esponente [n] Exponent [n]	1,355	1,359	1,338	1,393	1,418

COLONNE - COLUMNS					
Altezza (mm) Height (mm)	2	3	4	5	6
1800					
At 60 = [W]	171,7	230,1	290,1	348,7	403,4
At 50 = [W]	134,1	180,2	226,6	271,6	312,7
At 40 = [W]	99,1	133,6	167,6	200,1	229,0
At 30 = [W]	67,1	90,8	113,5	134,9	153,2
Interasse [mm] Pipe Centres [mm]	1744				
Contenuto [lt] Water Content [lt]	1,58	2,35	3,13	3,91	4,70
Peso a vuoto [kg] Dry Weight [kg]	2,60	3,91	5,22	6,53	7,84
Esponente [n] Exponent [n]	1,355	1,341	1,353	1,370	1,396

COLONNE - COLUMNS					
Altezza (mm) Height (mm)	2	3	4	5	6
2000					
At 60 = [W]	191,7	253,6	320,9	382,9	437,2
At 50 = [W]	149,8	199,0	250,3	299,0	339,8
At 40 = [W]	110,7	147,9	184,6	221,0	249,7
At 30 = [W]	75,0	100,9	124,7	149,6	167,8
Interasse [mm] Pipe Centres [mm]	1944				
Contenuto [lt] Water Content [lt]	1,74	2,59	3,45	4,31	5,20
Peso a vuoto [kg] Dry Weight [kg]	2,89	4,33	5,78	7,23	8,69
Esponente [n] Exponent [n]	1,355	1,330	1,364	1,356	1,382

COLONNE - COLUMNS					
Altezza (mm) Height (mm)	2	3	4	5	6
2200					
At 60 = [W]	212,3	276,9	352,1	416,7	469,6
At 50 = [W]	165,9	217,8	274,1	326,4	366,0
At 40 = [W]	122,6	162,3	201,7	242,0	269,7
At 30 = [W]	83,0	111,1	135,9	164,6	182,0
Interasse [mm] Pipe Centres [mm]	2144				
Contenuto [lt] Water Content [lt]	1,90	2,83	3,77	4,71	5,60
Peso a vuoto [kg] Dry Weight [kg]	3,17	4,76	6,35	7,94	9,53
Esponente [n] Exponent [n]	1,355	1,318	1,374	1,341	1,367

COLONNE - COLUMNS					
Altezza (mm) Height (mm)	2	3	4	5	6
2500					
At 60 = [W]	244,4	311,7	399,6	467,2	515,6
At 50 = [W]	190,9	245,9	310,2	367,4	403,4
At 40 = [W]	141,1	184,0	227,5	273,8	298,8
At 30 = [W]	95,5	126,6	152,5	187,4	202,9
Interasse [mm] Pipe Centres [mm]	2444				
Contenuto [lt] Water Content [lt]	2,14	3,19	4,25	5,31	6,40
Peso a vuoto [kg] Dry Weight [kg]	3,59	5,39	7,19	9,00	10,80
Esponente [n] Exponent [n]	1,355	1,301	1,389	1,318	1,345



COLONNE - COLUMNS					
Altezza (mm) Height (mm)	2	3	4	5	6
676					
At 60 = [W]	66,5	92,5	119,6	145,3	174,6
At 50 = [W]	52,4	72,8	94,0	114,0	138,0
At 40 = [W]	39,2	54,3	70,0	84,7	103,5
At 30 = [W]	27,0	37,2	47,8	57,7	71,4
Interasse [mm] Pipe Centres [mm]	620				
Contenuto [lt] Water Content [lt]	0,67	1,00	1,32	1,65	2,00
Peso a vuoto [kg] Dry Weight [kg]	1,02	1,53	2,05	2,57	3,09
Esponente [n] Exponent [n]	1,299	1,316	1,324	1,332	1,290

COLONNE - COLUMNS					
Altezza (mm) Height (mm)	2	3	4	5	6
876					
At 60 = [W]	84,7	117,8	151,0	182,5	217,4
At 50 = [W]	66,5	92,3	118,0	143,0	172,4
At 40 = [W]	49,4	68,5	87,2	106,1	129,7
At 30 = [W]	33,7	46,6	59,1	72,2	90,0
Interasse [mm] Pipe Centres [mm]	820				
Contenuto [lt] Water Content [lt]	0,83	1,24	1,65	2,05	2,50
Peso a vuoto [kg] Dry Weight [kg]	1,30	1,96	2,61	3,27	3,93
Esponente [n] Exponent [n]	1,327	1,339	1,355	1,338	1,273

COLONNE - COLUMNS					
Altezza (mm) Height (mm)	2	3	4	5	6
556					
At 60 = [W]	55,6	77,2	100,6	122,5	147,6
At 50 = [W]	44,0	60,9	79,3	96,2	116,5
At 40 = [W]	33,1	45,5	59,3	71,5	87,1
At 30 = [W]	22,9	31,3	40,7	48,8	60,0
Interasse [mm] Pipe Centres [mm]	500				
Contenuto [lt] Water Content [lt]	0,58	0,85	1,13	1,41	1,70
Peso a vuoto [kg] Dry Weight [kg]	0,85	1,28	1,71	2,14	2,58
Esponente [n] Exponent [n]	1,283	1,302	1,305	1,328	1,300

COLONNE - COLUMNS					
Altezza (mm) Height (mm)	2	3	4	5	6
656					
At 60 = [W]	64,7	90,0	116,5	141,5	170,2
At 50 = [W]	51,0	70,8	91,6	111,0	134,5
At 40 = [W]	38,2	52,8	68,2	82,5	100,8
At 30 = [W]	26,3	36,2	46,6	56,3	69,5
Interasse [mm] Pipe Centres [mm]	600				
Contenuto [lt] Water Content [lt]	0,66	0,97	1,29	1,61	1,90
Peso a vuoto [kg] Dry Weight [kg]	0,99	1,49	1,99	2,50	3,00
Esponente [n] Exponent [n]	1,297	1,314	1,320	1,331	1,292

COLONNE - COLUMNS					
Altezza (mm) Height (mm)	2	3	4	5	6
756					
At 60 = [W]	73,7	102,7	132,2	160,3	192,0
At 50 = [W]	58,0	80,6	103,6	125,7	152,0
At 40 = [W]	43,3	60,0	76,9	93,3	114,1
At 30 = [W]	29,7	41,0	52,4	63,6	78,9
Interasse [mm] Pipe Centres [mm]	700				
Contenuto [lt] Water Content [lt]	0,74	1,09	1,45	1,81	2,20
Peso a vuoto [kg] Dry Weight [kg]	1,13	1,70	2,28	2,85	3,42
Esponente [n] Exponent [n]	1,311	1,325	1,336	1,335	1,283

COLONNE - COLUMNS					
Altezza (mm) Height (mm)	2	3	4	5	6
856					
At 60 = [W]	82,8	115,3	147,9	178,8	213,2
At 50 = [W]	65,1	90,4	115,6	140,1	169,0
At 40 = [W]	48,4	67,1	85,5	103,9	127,2
At 30 = [W]	33,1	45,7	58,0	70,7	88,1
Interasse [mm] Pipe Centres [mm]	800				
Contenuto [lt] Water Content [lt]	0,82	1,21	1,61	2,01	2,40
Peso a vuoto [kg] Dry Weight [kg]	1,27	1,91	2,56	3,20	3,85
Esponente [n] Exponent [n]	1,324	1,337	1,352	1,338	1,275

COLONNE - COLUMNS					
Altezza (mm) Height (mm)	2	3	4	5	6
1656					
At 60 = [W]	157,6	213,2	268,0	324,0	378,0
At 50 = [W]	123,1	166,7	209,7	251,9	292,5
At 40 = [W]	91,0	123,3	155,3	185,1	213,7
At 30 = [W]	61,6	83,6	105,5	124,4	142,6
Interasse [mm] Pipe Centres [mm]	1600				
Contenuto [lt] Water Content [lt]	1,46	2,18	2,90	3,62	4,36
Peso a vuoto [kg] Dry Weight [kg]	2,40	3,61	4,81	6,02	7,23
Esponente [n] Exponent [n]	1,355	1,350	1,346	1,381	1,407

COLONNE - COLUMNS					
Altezza (mm) Height (mm)	2	3	4	5	6
1856					
At 60 = [W]	177,2	236,6	298,7	358,3	413,0
At 50 = [W]	138,4	185,5	233,3	279,3	320,4
At 40 = [W]	102,3	137,6	172,3	205,9	234,8
At 30 = [W]	69,3	93,6	116,7	139,0	157,3
Interasse [mm] Pipe Centres [mm]	1800				
Contenuto [lt] Water Content [lt]	1,62	2,42	3,22	4,02	4,84
Peso a vuoto [kg] Dry Weight [kg]	2,69	4,04	5,40	6,75	8,11
Esponente [n] Exponent [n]	1,355	1,338	1,356	1,366	1,392

COLONNE - COLUMNS					
Altezza (mm) Height (mm)	2	3	4	5	6
2056					
At 60 = [W]	197,4	260,1	329,6	392,4	446,4
At 50 = [W]	154,2	204,3	256,9	306,7	347,2
At 40 = [W]	114,0	151,9	189,4	226,9	255,3
At 30 = [W]	77,2	103,7	127,8	153,8	171,8
Interasse [mm] Pipe Centres [mm]	2000				
Contenuto [lt] Water Content [lt]	1,78	2,66	3,54	4,42	5,29
Peso a vuoto [kg] Dry Weight [kg]	2,98	4,47	5,96	7,45	8,95
Esponente [n] Exponent [n]	1,355	1,326	1,366	1,351	1,378

COLONNE - COLUMNS					
Altezza (mm) Height (mm)	2	3	4	5	6
586					
At 60 = [W]	58,3	81,0	105,4	128,3	154,5
At 50 = [W]	46,1	63,8	83,0	100,7	121,9
At 40 = [W]	34,6	47,7	62,0	74,8	91,3
At 30 = [W]	23,9	32,8	42,5	51,1	62,8
Interasse [mm] Pipe Centres [mm]	530				
Contenuto [lt] Water Content [lt]	0,60	0,89	1,18	1,47	1,77
Peso a vuoto [kg] Dry Weight [kg]	0,89	1,34	1,79	2,24	2,70
Esponente [n] Exponent [n]	1,287	1,306	1,309	1,329	1,298

COLONNE - COLUMNS					
Altezza (mm) Height (mm)	2	3	4	5	6
626					
At 60 = [W]	61,9	86,1	111,7	135,9	163,5
At 50 = [W]	48,9	67,8	87,9	106,6	129,1
At 40 = [W]	36,7	50,6	65,5	79,2	96,7
At 30 = [W]	25,3	34,7	44,9	54,0	66,7
Interasse [mm] Pipe Centres [mm]	570				
Contenuto [lt] Water Content [lt]	0,63	0,94	1,24	1,55	1,85
Peso a vuoto [kg] Dry Weight [kg]	0,95	1,43	1,91	2,39	2,87
Esponente [n] Exponent [n]	1,292	1,310	1,316	1,330	1,294

COLONNE - COLUMNS					
Altezza (mm) Height (mm)	2	3	4	5	6
786					
At 60 = [W]	76,4	106,5	136,9	165,9	198,4
At 50 = [W]	60,1	83,6	107,2	130,0	157,1
At 40 = [W]	44,9	62,1	79,5	96,5	118,1
At 30 = [W]	30,7	42,4	54,1	65,7	81,7
Interasse [mm] Pipe Centres [mm]	730				
Contenuto [lt] Water Content [lt]	0,76	1,13	1,50	1,87	2,25
Peso a vuoto [kg] Dry Weight [kg]	1,18	1,77	2,37	2,97	3,56
Esponente [n] Exponent [n]	1,315	1,329	1,341	1,335	1,281

COLONNE - COLUMNS					
Altezza (mm) Height (mm)	2	3	4	5	6
926					
At 60 = [W]	89,2	124,1	158,7	191,7	228,1
At 50 = [W]	70,0	97,2	123,9	150,1	180,7
At 40 = [W]	52,0	72,0	91,5	111,3	135,9
At 30 = [W]	35,4	48,9	61,9	75,6	94,1
Interasse [mm] Pipe Centres [mm]	870				
Contenuto [lt] Water Content [lt]	0,78	1,26	1,70	2,13	2,56
Peso a vuoto [kg] Dry Weight [kg]	1,29	1,95	2,60	3,26	3,92
Esponente [n] Exponent [n]	1,332	1,343	1,358	1,342	1,277



Interassi per sostituzione radiatori in **GHISA**
Pipe Centres for replacing **CAST IRON** radiators



Interassi per sostituzione radiatori in **ALLUMINIO**
Pipe Centres for replacing **ALUMINIUM** radiators



Interassi per sostituzione radiatori **LAMELLARI E STAMPATI**
Pipe Centres for replacing **LAMELLAR and PANEL** radiators



ARDESIA® CURVO - ARDESIA® CURVED



ARDESIA® AD ANGOLO - ARDESIA® ANGLED





Su richiesta è possibile realizzare Ardesia® in versione HYGIENIC, in tutte le configurazioni di allacciamento, altezze, dimensioni e finitura. Questa esecuzione amplia le capacità del tubolare Ardesia® di essere impiegato anche all'interno delle strutture sanitarie sottoposte alle più severe normative in materia di igiene negli impianti di riscaldamento. La speciale spaziatura degli elementi radianti consente la possibilità di effettuare un'accurata pulizia di tutta la superficie del radiatore a beneficio dell'igiene degli ambienti in cui Ardesia® HYGIENIC è installato. Per maggiori informazioni contattare la nostra area commerciale.

On demand, it is possible to realize Ardesia® in hygienic version, with all connections, heights, dimensions and finishings. This execution extends the water content of Ardesia® to be applied also to sanitary and community centers, subject to severe norms for hygiene in heating systems. The space between the sections has been conceived to facilitate an accurate cleaning on all radiator surface. For additional informations feel free to contact our sales department.

Anelli distanziatori saldati tra gli elementi con tecnologia robotizzata PULSED SPRAY WELDING
Space rings between sections welded with robotized technology of PULSED SPRAY WELDING

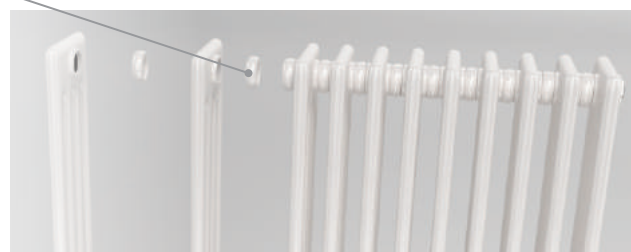

ARDESIA® CON PIEDINI SALDATI - ARDESIA® WITH WELDED FEET

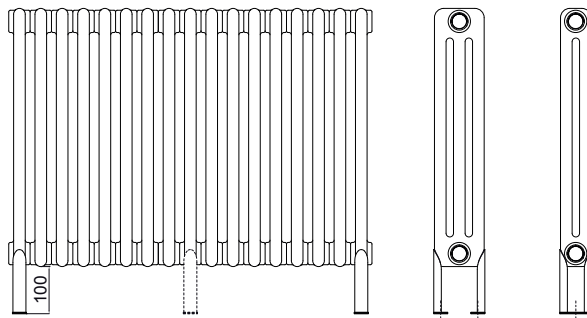

FISSAGGI RAPIDI DI SICUREZZA VDI 6036 RAPID FIXING SAFETY KIT VDI 6036

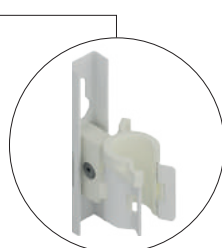
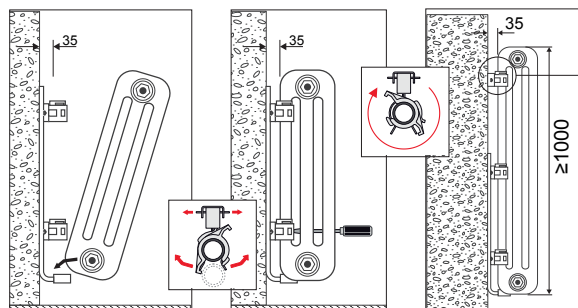

ARDESIA® ELETTRICO - ELECTRIC



- Teste stampate in lamiera di acciaio al carbonio.
- Tubi in acciaio al carbonio elettrouniti \varnothing 25 mm.
- Completo di fluido termovettore.
- Colore standard Bianco R01.

- Pressed heads in carbon steel sheet.
- Welded carbon steel tube \varnothing 25 mm.
- Glycolate water.
- Standard color White R01.

CERTIFICAZIONI - PRODUCT CERTIFICATES



IP 22
Classe II

ACCESSORI - ACCESSORIES



APPENDIABILI
HOOKS



TELECOMANDO AD INFRAROSSI
INFRARED REMOTE CONTROL

Altezza Height	Larghezza Width	N° Elementi N° Elements	N° Colonne N° Columns	Potenza termica Output
H [mm]	L [mm]			[Watt]
600	338	7	3	400
	384	8	3	500
	568	12	3	750
	614	13	3	900
	706	15	3	1000
	798	17	3	1200
	982	21	3	1500
	1120	24	3	2000

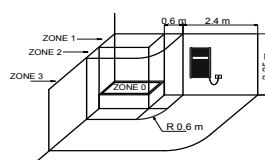

PRESCRIZIONI DI INSTALLAZIONE - INSTALLATION REQUIREMENTS

Vanno scrupolosamente rispettate le norme nazionali sull'installazione di apparecchiature elettriche nei locali da bagno. I radiatori elettrici vanno sempre installati al di fuori delle Zone 1 e 2. In particolare la presa di alimentazione, l'interruttore e gli organi di comando devono essere posizionati obbligatoriamente in zona 3, in modo che nessun organo di comando elettrico deve essere accessibile da una persona che utilizza la doccia o la vasca. The national rules on installing electrical equipment in the bathroom must be scrupulously respected. The electric radiators must be always installed outside zone 1 and 2. In particular the electric switch and control elements must be mandatorily located in zone 3, in order that no electrical control center is accessible to anyone using the shower or bath.

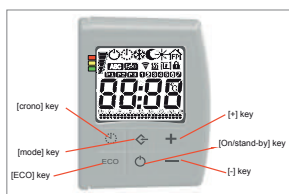
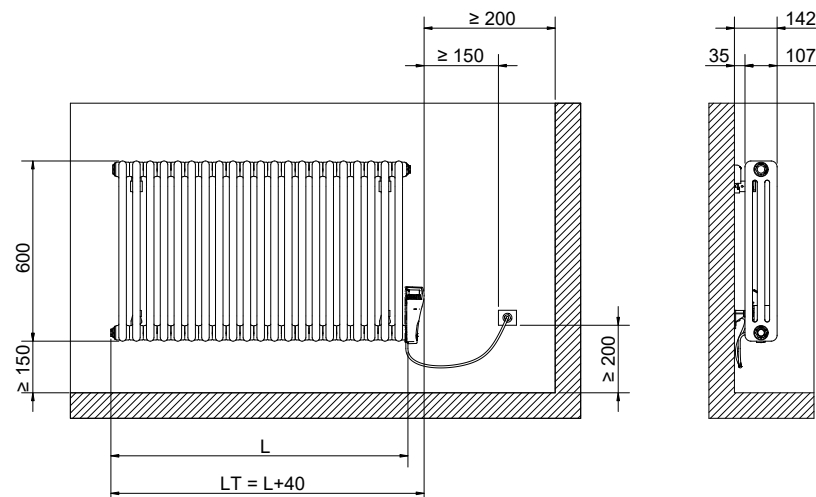

**TERMOSTATO DIGITALE
PROGRAMMABILE CON
FUNZIONE GIORNALIERA
E SETTIMANALE**

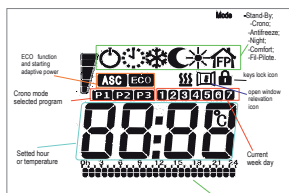

**PROGRAMMABLE DIGITAL
THERMOSTAT WITH DAILY
AND WEEKLY FUNCTION**





COLOURS

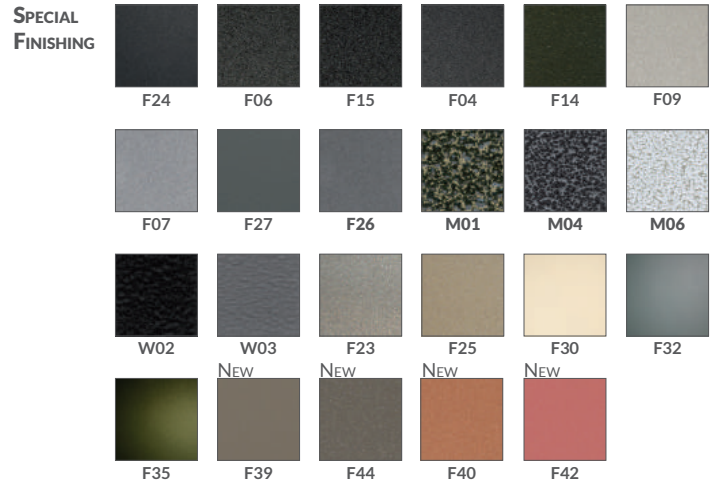
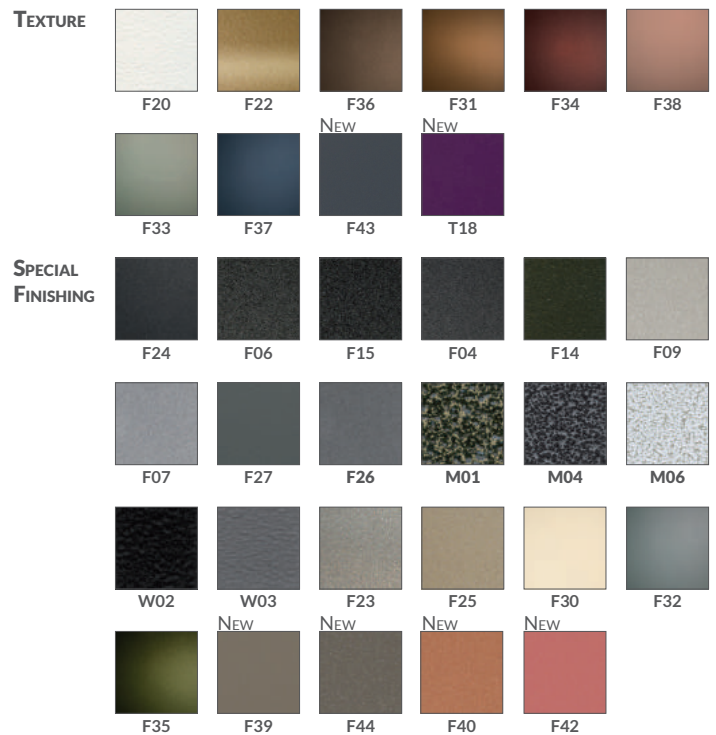
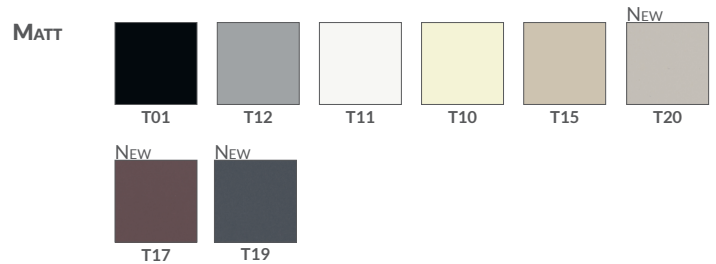
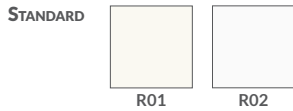

F28
ARDESIA® SHINY TRANSPARENT

ARDESIA® SHINY TRANSPARENT

A richiesta, esclusivamente sui radiatori tubolari Ardesia®, è possibile avere la nuova finitura trasparente **SHINY TRANSPARENT**. Una finitura in grado di valorizzare gli ambienti più moderni esaltando le caratteristiche tecniche e costruttive dei radiatori tubolari Ardesia®.

On request exclusively on tubular radiator Ardesia® you can have the new transparent **SHINY TRANSPARENT** finish. A finish that will enhance the modern environments extolling the technical and constructive characteristics of tubular radiator Ardesia®.

Per l'esatta consultazione delle tinte riferirsi alla cartella colori Cordivari COLOUR SYSTEM.
Please refer to Cordivari COLOUR SYSTEM chart, in order to see the real colour.



FOLLOW US



www.cordivari.com

